

UTICA

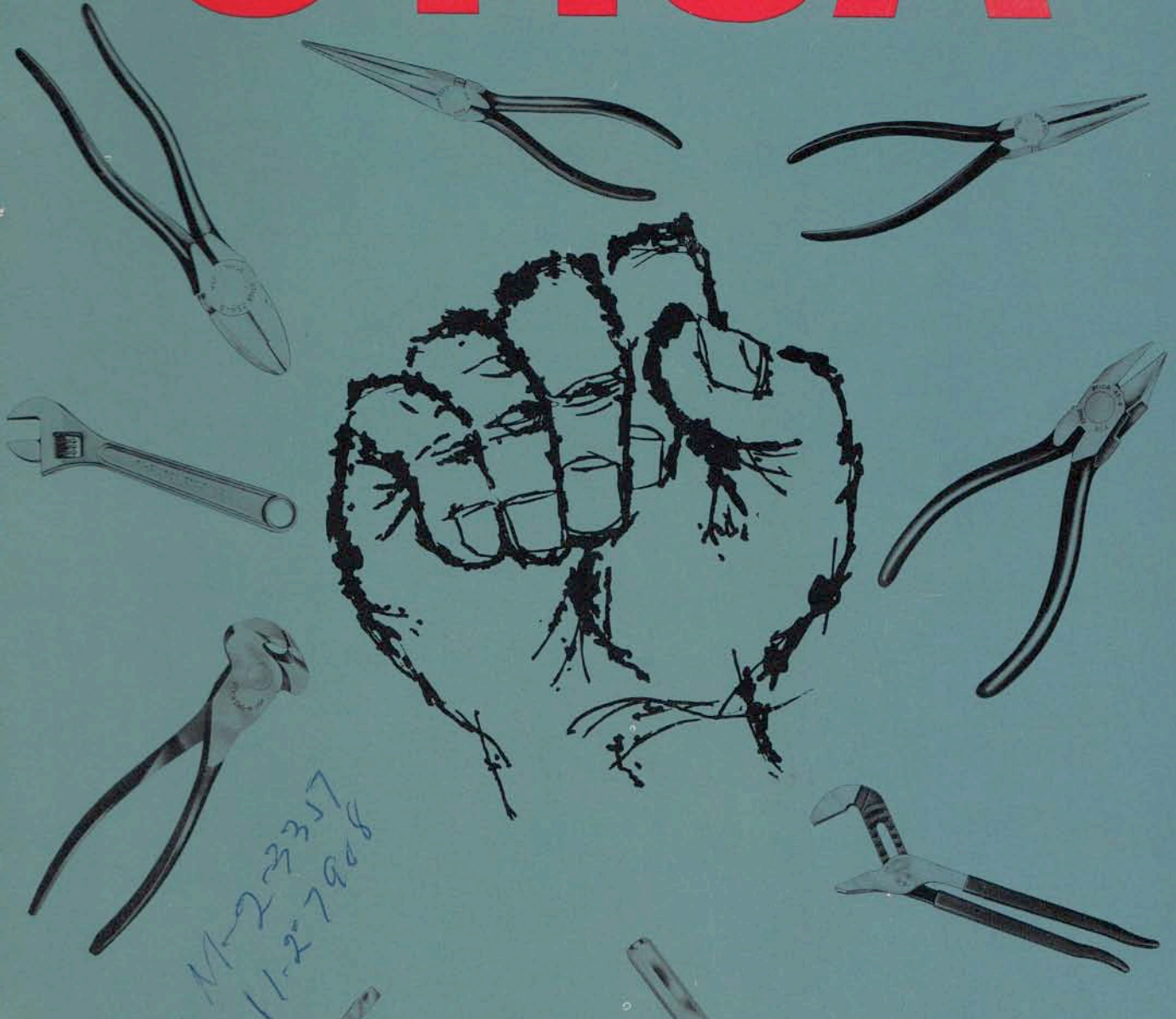

M-2-3317
11-2-7908

ADD POWER TO YOUR HANDS

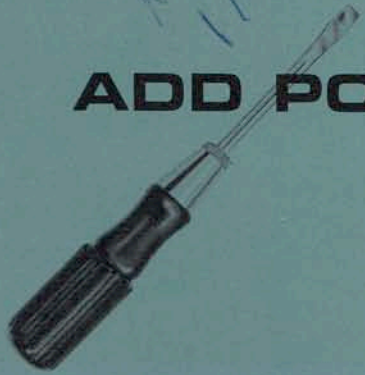

UTICA TOOL CO., INC.

Subsidiary of The Triangle Corporation
Orangeburg, South Carolina 29115

TOOL DIVISION AIM . . . EXPAND TO MEET DEMAND

TO OUR VALUED CUSTOMERS

At the new UTICA plant in Orangeburg, South Carolina, advanced design and manufacturing capabilities are blended with modern engineering and production equipment to produce tools of the finest quality. This exceptionally high quality is now available in more tools than ever before. As you use this catalog you will notice that the UTICA line has been greatly expanded to meet an ever-growing demand.

Distribution throughout the United States and Canada has been improved, too. Stock warehouses established at key points from coast to coast provide you with the utmost in convenience, service and cooperation.

Also available from UTICA are the services of a new Custom Tool Shop which specializes in the design and manufacture of special tools for a wide range of purposes and applications.

GUARANTEE

The trade mark "UTICA" is your unqualified guarantee against any defects in quality or workmanship. Each tool is designed and engineered with plus strength factors to perform the maximum service on the job for which it is intended. Any tool failing in normal use may be returned prepaid to the factory and if our inspection reveals the failure due to defective quality or workmanship, it will be repaired or replaced and returned without charge.





NUMERICAL INDEX

Tool No.	Page No.	Tool No.	Page No.	Tool No.	Page No.	Tool No.	Page No.
PLIERS AND ADJUSTABLE WRENCHES		225	9	777	10	Solid	27
5	5	226	9	778	10	Drift	27
7	5	227	9	779	10	Prick	27
8	5	241	13	818	15	Center	27
9	5	242	13	819	15	RIVET BUSTERS	
11	5	254	9	820	15	U-90607	27
20	7	259	7	888	11	RIVET SETS	
21	10	260	11	896	9	U-90608	27
22	8	261	8	897	9	PINCH BARS	
23	8	262	11	926	10	U-90600	27
24	14	265	9	931	8	STAR DRILLS	
25	8	270	15	982	11	12" only	28
31	7	272	16	1000	14	OFFSET SCREWDRIVERS	
34	12	273	16	1033	10	U-90185	25
38	11	275	15	1100	14	U-90186	25
39	12	280	16	1300	14	U-90187	25
40	12	281	16	1932	15	SCREWDRIVER DISPLAY AND ASSORTMENT	
41	12	282	16	1933	15	U-88230	28
42	12	296	9	1950	7	DISPLAYS	
43	12	360	11	2001	14	H-17	29
44	12	400	13	2291	9	H-18	30
45	12	402	14	3950	7	J-2	32
46	12	441	13	20820	16	R-1	29
47	13	470	13	20821	16	R-2	29
48	13	506	5	U-84001	16	W-5	31
49	13	507	5	RW-100	22	W-8	31
50	7	508	5	UA-200	21	W-9	31
52	7	511	6	UA-200 B5	21	W-10	31
63	11	512	6	UA-200 B6	21	Special	32
64	11	513	6	UA-200 B7	21	Electronic	30
65	11	517	6	UA-200 B8	21	COLD CHISELS	
82	11	520	6	UA-300	21	Regular Taper	27
84	8	523	6	SW-1	21	Extra Long	27
85	8	524	6	SW-1L	21	Diamond Point	27
86	8	525	14	Electronic Tools	19, 20, 21, 22	PUNCHES	
87	8	527	7			Pin (Regular)	27
90	23	529	7			Pin (Extra Long)	27
91	23	534	14			PLIER AND WRENCH TYPE INDEX	
93	23	535	14				
94	23	538	6				
100	15	561	16				
101	16	562	16				
110	15	622	9				
141	13	650	8				
146	13	654	10				
159	7	750	15				
180	14	774	10				
		775	10				
		776	10				

Page No.	Page No.	Page No.			
Adjustable Wrenches	23	Full Polished Pliers	3	"Rib-Joint" Pliers	5 & 6
Battery Pliers	6	Gas Burner Pliers	14	Round Nose Pliers	10
Button Pliers	14	Gift Kits	33 & 34	Screwdrivers	25, 26 & 28
BX Cable Cutting Pliers	15	Hog Ring Pliers	15	Side Cutting Pliers	6, 7, 8, 9, 10
Chain Nose Pliers	8, 9, 10	Hoisery Mill Pliers	8	Skin-Packaged Tools	18
Chipping Knives	16	Ignition Pliers	6	Slip-Joint Pliers	5 & 6
Chisels	29	Linemans Pliers	7	Snap Ring Pliers	16
Cloth Stretching Pliers	14	Lock Ring Pliers	14	Snips	15 & 16
Combination Feature Chart	2	Needle Nose Pliers	10 & 11	Special Handles	3
Cushion Throat Feature	4	Nippers	11	Spinner Wrenches	28
Custom Built Pliers	22 & 24	Nut Drivers	28	Springs for Pliers	4
Diagonal Pliers	11, 12, 13	Parallel Action Pliers	13 & 14	Standard Feature Chart	2
Displays	29, 30, 31 & 32	Plastic Cutting Pliers	13	Wire Strippers	15 & 21
Electronic Tools	19, 20, 21, 22	Power Tools	21	Wrenches, Adjustable	23
Fence Pliers	15	Punches	27		
Finishes, Special	3	Rapid-Wrapit Tools	22		
Flat Nose Pliers	7 & 8	Retaining Ring Pliers	16		



For the convenience of our customers we have listed the most frequently ordered tools with various features.

STANDARD FEATURE CHART

COMBINATION FEATURE CHART

UTICA LETTER CODED STANDARD AND SPECIAL FEATURES

Old Tool No.	Old Letter Code	C	D	F	G	H	J	K	N	O	R	S	T
	New No. Code	10	40	32	33	34	35	36	37	30	38	31	39
20.4" ● 4 1/2"		✓	★	★	■	★				★	★	★	
20.5" ● 6"		✓	★	★	★	■				★	★	★	
21.4" ● 4 1/2"		✓	★	★	■	★				★	★	★	
21.5" ● 6"		✓	★	★	★	■				★		★	
22.4" ● 4 1/2" (4 1/2 Sp. Hole Std.)		✓	★	★	★	★				★	★	★	
22.5" ● 6"		✓	★	★	★	■				★	★	★	
23.4" ● 4 1/2" ● 5"		✓	★	★	★	■				★	✓	✓	
23.6"		■	★	■	✓	■				★	✓	■	
31.8"		✓	★	★	★	■				★	★	★	
34.6"		■	■										■
38.4"		✓	✓	✓			★	■	★			✓	
39.7" ● 40.7" ● 41.5" ● 6"		✓		★			★	★	★			★	✓
41.4"		✓		★			■	★	✓			✓	✓
42.4"		✓		★			■	★	★			✓	
43.5" ● 6"		✓		★			★	★				★	
44.5" ● 6"		✓		★			✓	■	★			✓	✓
45.6"		✓		★			✓	★	★			★	
46.4"		✓		✓			★	★	★			✓	✓
47.4"		✓		★			■	★				✓	
48.6" ● 7"		✓		★			■					■	
49.6"		✓		★			★	■	★			✓	✓
50.4" ● 5" ● 6" ● 7" ● 8"		✓		★		■							
52.6" ● 7" ● 8"		✓		★		■							
63.4" ● 64.4"		✓		■			■					✓	
65.4 1/2" ● 5"		✓		✓			★					★	
82.8"		✓	★	★	★	■				★	★	★	
84.6"		✓	★	★	■	✓				★	★		
85.5 1/2"		✓	★	★	■					★		★	
86.6"		✓	★	★	★	■				★	★	★	
87.7"		✓	★	★	■	★				★	★	★	
141.5" ● 6"		✓		★			■		★			✓	
146.4"		■		■								■	
159.9"		✓		★		■							
225.6 1/2"		■		★		■							
226.6 1/2"		✓	★	★		■				★		★	
227.6 1/2"		✓	★	★		■				★		✓	
241.5" ● 5 1/2" ● 6"		✓		★			★		★			✓	
242.5 1/2" ● 6"		✓		★			★					★	
254.6 1/2"		✓		★	★	■	✓					✓	
259.6" ● 7" ● 8"		✓		★		■						✓	
260.6" ● 7" ● 8"		✓		★			★					★	
261.4 1/2"		✓		★		■	■					✓	
262.5 1/2"		✓		★								✓	
265.5"		■		★		■						■	
296.6 1/2"		✓		★								✓	
441.5 1/2"		✓		★			★		★			■	
470.5"		✓		★								■	
622.5"		✓	★	★		■			★	★		✓	
650.6"		✓	★	★		■			★	★		✓	
654.5 1/2"		✓		★		■			★			✓	
654.6" ● 7"		✓		★		■			★			✓	
774.5 1/2"		■	★	■	■	★				★	★	■	
775.5 1/2"		✓	★	★	★	■				★	★	✓	
776.6"		✓	★	★	★	■				★		✓	
777.6"		✓	★	★	★	■				★	★	✓	
778.6 1/2"		✓	★	★	★	■				★	★	✓	
779.6"		✓		★	★	■					★	✓	
818.7"		✓		★								✓	
888.6"		✓	★	★	★	■				★	★	★	
896.6"		✓		★		■			★			✓	
926.6 1/2"		✓	★	★	★	■						✓	
931.8" ● 982.8"		✓		★	★	■						✓	
1000.8" ● 10"		✓		■		■							
1033.5 1/2"		✓	★	★	★	■				★	★	✓	
1033.6" ● 7"		✓	★	★	★	■				★	★	✓	
1300.6" ● 8" ● 10"		✓	★	★		■				★			
1950.6" ● 7" ● 8"		✓				■							
3950.6" ● 7" ● 8"		■				■							

OLD LETTER CODE	NEW NO. CODE
CD	50
CF	12
CFGFS	52
CFGRS	58
CFHS	62
CFHRS	68
CFRS	48
CFS	22
CG	13
CGS	23
CH	14
CHS	24
CJ	15
CJS	25
CN	17
CNS	27
CR	18
CRS	28
CS	11
CST	29
CT	19
GR	43
GS	53
HS	54
JN	65
JS	55
NS	57
ST	59

WHEN ORDERING COMBINATIONS OF FEATURES NOT LISTED ABOVE PLEASE SPECIFY ON ORDER.

SPECIAL FEATURES

- "C" (10) Cushion Handle
- "D" (40) Full Polish and Ni. Chrome
- "F" (32) Full Polish
- "G" (33) Plain, Unscored Jaws
- "H" (34) Fine Serrated Jaws
- "J" (35) Flush Edges
- "K" (36) Semi-Flush Edges
- "N" (37) Cushion Throat
- "O" (30) Ni. Chrome Plate
- "R" (38) Radius on Jaws
- "S" (31) Spring
- "T" (39) Ribbed Cushion Throat

- STANDARD FEATURES
- ✓ FEATURES AVAILABLE FROM STOCK
- ★ SPECIAL - DELIVERY (30-45 DAYS)
- NOT AVAILABLE

SEE UTICA PRICE LIST FOR DETAIL CODE DESCRIPTION

● special finishes

For applications requiring them, UTICA pliers can be provided with various finishes as listed below. These finishes are not standard and must be specified.

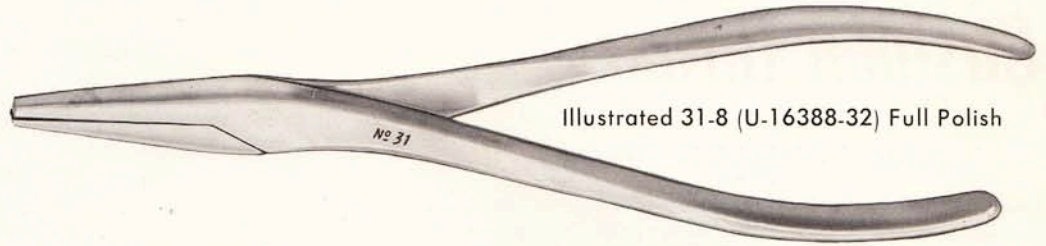

Illustrated 31-8 (U-16388-32) Full Polish

FULL POLISHED

To order add letter "F" (32) to tool number i.e. 21.4"F (U-16614-32).

NICKEL-CHROME

(Plated over standard finish.) To order add letter "O" (30) to tool number i.e. (U-13145-30).

POLISHED-PLATED

(Full polish and nickel chrome.) To order add letter "D" (40) to tool number i.e. 45.6" D (U-13156-40).

● special handles

"CUSHION GRIP"

Dipped and baked plastic handles give extra comfort and extra long service. Particularly effective on assembly lines and electrical applications. Applied at the factory to any pliers or wrench. Different colors can be used for coding. To order add letter "C" (10) to tool number (i.e. 41-5"C) (U-13115-10). Dielectric Value not guaranteed.

SLIP-ON

Red plastic handles with deep knurling for a positive but comfortable grip. Non-burning and non-explosive, they will stand up under extreme temperature changes. Easily applied . . . "just hammer them on." Sizes: 6", 7", 8".

Dielectric Value not guaranteed. 6" - No. U-19656
7" - No. U-19657
8" - No. U-19658



● jaw serrations (PLIERS)

PLAIN UNSCORED JAWS

To order add letter "G" (33) to tool number i.e. 86-6"G (U-16316-33). No additional charge.

FINE SERRATED JAWS

To order add letter "H" (34) to tool number i.e. 22-4"H (U-16114-34). No additional charge.

● special optional FEATURES

Convenience and safety device for pliers used for cutting electrical and spring wire . . . holds short end of wire during and after cutting.

Cushion throat

(UTICA PATENT)

RIBBED CUSHION THROAT

Plastisol cushion is held securely and permanently with milled serrations. To order add letter "T" (39) to tool number. Available only on following tools: 39-7" T (U-13137-39), 40-7" T (U-13447-39), 41-4" T (U-13114-39), 41-5" T (U-13115-39), 41-6" T (U-13116-39), 44-5" T (U-13145-39), 46-4" T (U-13214-39).

PLAIN CUSHION THROAT

Without milled grooves, applicable to most UTICA Diagonal or Side Cutting Pliers. To order add letter "N" (37) to tool number - i.e. 41-6" N (U-13116-37).

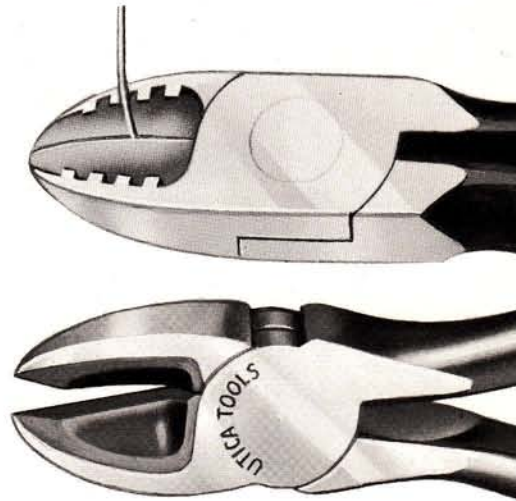

● cutting edges

FLUSH EDGES

To order add letter "J" (35) to tool number i.e. 44-5" J (U-13145-35).

SEMI-FLUSH EDGES

To order add letter "K" (36) to tool number i.e. 41-6" K (U-13116-36).



Coil spring

Easily removable coil spring guaranteed against breakage. It won't pinch the fingers. Permits easy use of slip-on handles and can be applied to almost any plier. To order add letter "S" (31) to tool number (i.e. 41-5" S) (U-13115-31).

When ordering, please use new tool number.

No. 5 • Combination Slip-Joint Pliers—Chrome Plated



Old No.	New No.	Dim. A	Dim. B	Dim. C	Wt. ea. lbs.
5-6"	U-11116	1.094	1.188	.406	.417

No. 506 • "Rib-Joint"[®] Heavy Duty Pliers

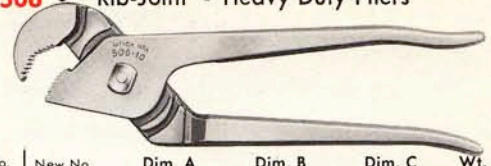

Old No.	New No.	Dim. A	Dim. B	Dim. C	Wt. ea. lbs.
506-10"	U-12240	.927	2.094	.460	1.000

No. 7 • Combination Slip-Joint Pliers — Chrome Plated

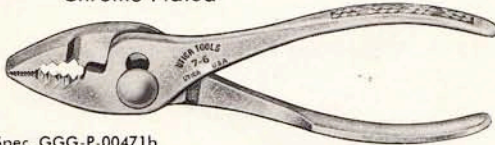

Fed. Spec. GGG-P-00471b
Type II, Class 2, Style A (6", 8" & 10" sizes).

Old No.	New No.	Dim. A	Dim. B	Dim. C	Wt. ea. lbs.
7-5"	U-11125	.922	1.062	.343	.096
6"	U-11126	1.094	1.188	.406	.417
8"	U-11128	1.312	1.250	.438	.646
10"	U-11120	1.515	1.500	.515	1.063

No. 507 • "Rib-Joint"[®] Ignition Pliers

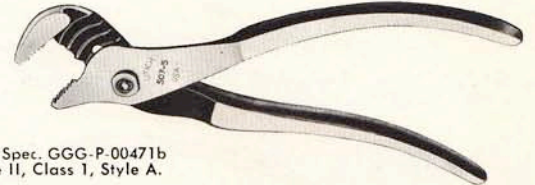

Fed. Spec. GGG-P-00471b
Type II, Class 1, Style A.

Old No.	New No.	Dim. A	Dim. B	Dim. C	Wt. ea. lbs.
507-5"	U-12235	.450	.913	.187	.125

No. 8 • Combination Slip-Joint Pliers — Polished and Chrome Plated

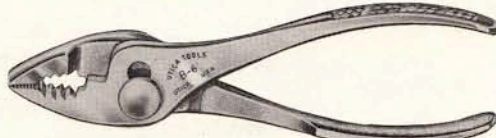

Old No.	New No.	Dim. A	Dim. B	Dim. C	Wt. ea. lbs.
8-5"	U-11135	.922	1.062	.343	.096
6"	U-11136	1.094	1.188	.406	.417
8"	U-11138	1.312	1.250	.438	.646
10"	U-11130	1.515	1.500	.515	1.063

No. 507 • "Rib-Joint"[®] Utility Pliers



Fed. Spec. GGG-P-00471b
Type II, Class 1, Style A (10" size).

Old No.	New No.	Dim. A	Dim. B	Dim. C	Wt. ea. lbs.
507-6½"	U-12236	.804	1.492	.297	.292
10"	U-12230	1.156	2.031	.281	.750

No. 9 • Bent Thin Nose Combination Slip-Joint Pliers—Polished and Chrome Plated



Old No.	New No.	Dim. A	Dim. B	Dim. C	Wt. ea. lbs.
9-6"	U-11176	1.313	1.188	.219	.417

No. 507 • "Rib-Joint"[®] Utility Pliers

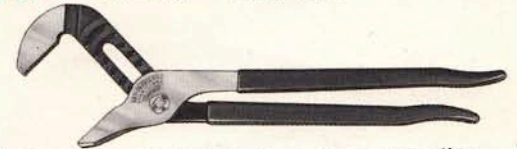

Plastisol handles are standard. Maximum jaw opening 2¹³/₁₆".

Old No.	New No.	Dim. A	Dim. B	Dim. C	Wt. ea. lbs.
507-14"	U-12234	2.000	3.125	.437	2.000

No. 11 • Thin Nose Combination Slip-Joint Pliers — Polished and Chrome Plated



Fed. Spec. GGG-P-00471b
Type II, Class 2, Style B.

Old No.	New No.	Dim. A	Dim. B	Dim. C	Wt. ea. lbs.
11-5"	U-11145	.906	1.063	.172	.166
6"	U-11146	1.313	1.188	.219	.313

No. 508 • "Rib-Joint"[®] Utility Pliers



With smooth jaws for brass and chrome fittings. Plastisol handles are standard. Max. jaw opening 2¹³/₁₆".

Old No.	New No.	Dim. A	Dim. B	Dim. C	Wt. ea. lbs.
508-14"	U-12244	2.000	3.125	.437	2.000

NOTE: For other information pertaining to dimensions, refer to Mechanical Drawings, Page 17

When ordering, please use new tool number.

No. 511 • Heavy Duty Slip-Joint Pliers

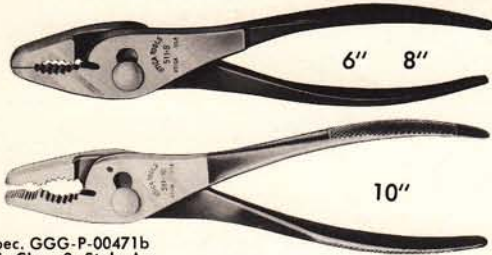

Fed. Spec. GGG-P-00471b
Type II, Class 2, Style A.

Old No.	New No.	Dim. A	Dim. B	Dim. C	Wt. ea. lbs.
511-6"	U-12156	1.000	1.250	.406	.479
8"	U-12158	1.094	1.281	.437	.708
10"	U-12150	1.438	1.469	.469	.896

No. 512 • Heavy Duty Bent Nose Slip-Joint Pliers



Fed. Spec. GGG-P-00471b
Type II, Class 3, Style A.

Old No.	New No.	Dim. A	Dim. B	Dim. C	Wt. ea. lbs.
512-8"	U-12168	1.094	1.281	.469	.708
10"	U-12160	1.438	1.469	.469	1.042

No. 513 • Mechanic's Slip-Joint Side Cutting Pliers



Old No.	New No.	Dim. A	Dim. B	Dim. C	Dim. D	Wt. ea. lbs.
513-5½"	U-12485	1.250	1.125	.281	.344	.313
7"	U-12487	1.750	1.250	.410	.375	.583

No. 517 • Ignition Pliers



Fed. Spec. GGG-P-00471b
Type II, Class 1, Style B.

Old No.	New No.	Dim. A	Dim. B	Dim. C	Wt. ea. lbs.
517-5"	U-12385	.450	.900	.184	.104

No. 517 • Water Pump and Electrician's Lock Nut Pliers

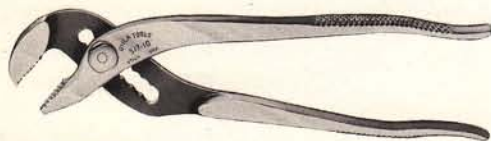

Fed. Spec. GGG-P-00471b
Type II, Class 1, Style B.

Old No.	New No.	Dim. A	Dim. B	Dim. C	Wt. ea. lbs.
517-10"	U-12380	1.125	2.187	.292	.688

No. 520 • Midget Ignition Pliers

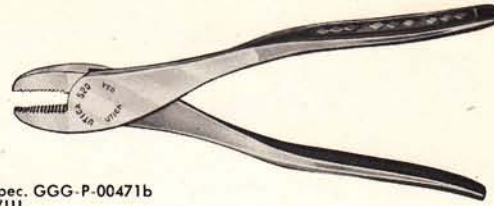

Fed. Spec. GGG-P-00471b
Type VIII.

Old No.	New No.	Dim. A	Dim. B	Dim. C	Wt. ea. lbs.
520-4½"	U-18244	.500	.578	.172	.104

No. 523 • Angle Nose Gripping Pliers



Old No.	New No.	Dim. A	Dim. B	Dim. C	Wt. ea. lbs.
523-7"	U-12387	.750	1.625	.313	.417

No. 524 • Angle Nose Battery Pliers



Fed. Spec. GGG-P-00471b
Type I.

Old No.	New No.	Dim. A	Dim. B	Dim. C	Wt. ea. lbs.
524-7"	U-18217	.596	1.250	.312	.500

No. 538 • Hose Clamp Pliers



Old No.	New No.	Dim. A	Dim. B	Dim. C
538-8"	U-12818	1.078	1.281	.437

UTICA has hundreds of Custom Built Pliers, not illustrated in this catalog, designed to perform specific jobs. Write the Utica Sales Department for further information.

When ordering, please use new tool number.

No. 527 • A-N Electrical Connector Pliers



Designed to fit A-N electrical connector nuts.

Old No.	New No.	Dim. A	Dim. B	Dim. C	Wt. ea. lbs.
527-10"	U-12820	1.600	2.468	.375	.650

No. 529 • A-N Connector Pliers

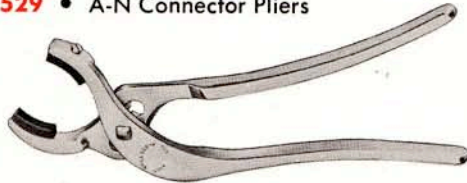

With nylon inserts for protection of connectors.

No. U-12830-3 - Replacement Inserts

Old No.	New No.	Dim. A	Dim. B	Dim. C	Wt. ea. lbs.
529-10"	U-12830	1.600	2.531	.375	.656

No. 50 • Electrician's Standard Side Cutting Pliers



Fed. Spec. GGG-P-00471b
Type IX, Class 1, Style A (5", 6" and 8" sizes).
With plastisol dipped handles - Type IX, Class 1, Style B (5", 6" and 8" sizes).

Old No.	New No.	Dim. A	Dim. B	Dim. C	Dim. D	Wt. ea. lbs.
50-4"	U-14614	.719	.588	.344	.391	.166
5"	U-14615	.813	.625	.375	.438	.250
6"	U-14616	1.094	.830	.500	.625	.500
7"	U-14617	1.125	.906	.563	.625	.645
8"	U-14618	1.281	1.031	.563	.688	.813

No. 52 • Side Cutting Pliers with Closed Nose and Fine Checked Jaw



Special design for certain applications handling fine wire.

Old No.	New No.	Dim. A	Dim. B	Dim. C	Dim. D	Wt. ea. lbs.
52-6"	U-14626	1.094	.830	.500	.625	.500
7"	U-14627	1.125	.906	.563	.625	.645
8"	U-14628	1.281	1.031	.563	.688	.813

No. 159 • New England Head High Leverage Lineman's Side Cutting Pliers with Crusher



Special offset rivet and larger handles give much greater leverage.

Old No.	New No.	Dim. A	Dim. B	Dim. C	Dim. D	Wt. ea. lbs.
159-9"	U-14439	1.600	1.250	.625	.786	1.042

No. 259 • New England Head Lineman's Side Cutting Pliers



Old No.	New No.	Dim. A	Dim. B	Dim. C	Dim. D	Wt. ea. lbs.
259-6"	U-14416	1.094	.938	.437	.625	.458
7"	U-14417	1.281	1.063	.500	.688	.646
8"	U-14418	1.438	1.188	.610	.748	.938

No. 1950 • Lineman's Heavy Duty Side Cutting Pliers



Old No.	New No.	Dim. A	Dim. B	Dim. C	Dim. D	Wt. ea. lbs.
1950-6"	U-14456	1.094	.938	.437	.625	.458
7"	U-14457	1.250	1.125	.500	.688	.645
8"	U-14458	1.503	1.250	.625	.750	.979

No. 3950 • Lineman's Heavy Duty Side Cutting Pliers with Plastisol Insulated Handles



Especially recommended for utility field (dielectric value not guaranteed).

Old No.	New No.	Dim. A	Dim. B	Dim. C	Dim. D	Wt. ea. lbs.
3950-6"	U-14466	1.094	.938	.437	.625	.520
7"	U-14467	1.250	1.125	.500	.688	.771
8"	U-14468	1.503	1.250	.625	.750	1.167

No. 20 • Flat Nose Pliers

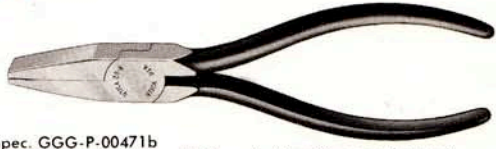

Fed. Spec. GGG-P-00471b
4", 5" and 6" sizes - Type V, Class 2. (Specify scored jaws.)

Scored jaws standard on 5" and 6" sizes.
Plain jaws standard on 4" and 4 1/2" sizes.

Old No.	New No.	Dim. A	Dim. B	Dim. C	Wt. ea. lbs.
20-4"	U-16324	.906	.438	.281	.125
4 1/2"	U-16321	1.062	.438	.281	.146
5"	U-16325	1.141	.562	.328	.230
6"	U-16326	1.313	.688	.406	.375

No. 31 • Flat Nose Wiring Pliers



Fed. Spec. GGG-P-00471b
Type XV, Class 2.

Also extensively used in typewriter repair and assembly work.

Old No.	New No.	Dim. A	Dim. B	Dim. C	Wt. ea. lbs.
31-8"	U-16388	1.375	.562	.438	.417

NOTE: For other information pertaining to dimensions, refer to Mechanical Drawings, Page 17

When ordering, please use new tool number.

No. 84 • Long Thin Flat Nose Pliers



Plain Jaws Standard
Designed for adjusting springs
in confined places. Used in telephone work.

Old No.	New No.	Dim. A	Dim. B	Dim. C	Dim. E	Wt. ea. lbs.
84-6"	U-16336	2.063	.625	.219	.040	.333

No. 85 • Flat Nose Pliers with Convex and Concave Jaws



Jaws unscored. Weaver's or
knitter's pliers for straighten-
ing thin reeds and needles.

Old No.	New No.	Dim. A	Dim. B	Dim. C	Dim. E	Wt. ea. lbs.
85-5½"	U-16385	1.750	.500	.313	.030	.166

**No. 87 • Extra Long Flat Nose Pick Up Pliers
(Smooth Jaws)**



Fed. Spec. GGG-P-00471b
Type V, Class 1. (With scored jaws.)

(7"—Hosiery Mill)

Old No.	New No.	Dim. A	Dim. B	Dim. C	Dim. E	Wt. ea. lbs.
87-7"	U-16337	2.656	.656	.375	.094	.333

No. 86 • Flatnose Pliers



Fed. Spec. GGG-P-00471b
Type V, Class 3; Style A. (With scored jaws.)
Serrated Jaws Standard

Old No.	New No.	Dim. A	Dim. B	Dim. C	Dim. E	Wt. ea. lbs.
86-6"	U-16316	2.250	.656	.375	.090	.292

No. 650 • Long Reach Flat Nose Side Cutting Pliers



Fed. Spec. GGG-P-00471b
Type V, Class 3, Style B.

Old No.	New No.	Dim. A	Dim. B	Dim. C	Dim. D	Dim. E	Wt. ea. lbs.
650-6"	U-14316	2.250	.656	.375	.437	.090	.292

No. 931 • Box Joint Flat Nose Wiring Pliers



Box joint keeps perfect alignment.

Old No.	New No.	Dim. A	Dim. B	Dim. C	Wt. ea. lbs.
931-8"	U-16348	1.656	.500	.375	.417

No. 22 • Short Chain Nose Pliers

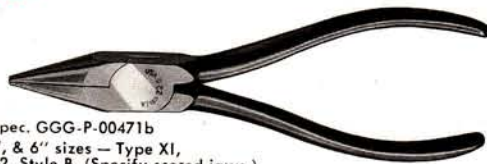

Fed. Spec. GGG-P-00471b
4", 5", & 6" sizes — Type XI,
Class 2, Style B. (Specify scored jaws.)

Scored jaws standard on 5"
and 6" sizes. Plain jaws standard on 4" and 4½".

Old No.	New No.	Dim. A	Dim. B	Dim. C	Dim. E	Wt. ea. lbs.
22-4"	U-16114	.906	.406	.266	.078	.125
4½"	U-16111	1.062	.438	.281	.062	.146
5"	U-16115	1.125	.562	.328	.094	.208
6"	U-16116	1.312	.688	.406	.125	.333

**No. 23 • Short Chain Nose Pliers,
Very Thin Nose**

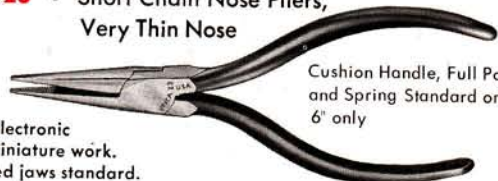

Cushion Handle, Full Polish
and Spring Standard on
6" only

For electronic
subminiature work.
Scored jaws standard.

Old No.	New No.	Dim. A	Dim. B	Dim. C	Dim. E	Wt. ea. lbs.
23-4"	U-16124	.906	.359	.234	.047	.087
4½"	U-16121	1.031	.400	.250	.054	.103
5"	U-16125	1.125	.406	.250	.078	.146
6"	U-16126	.843	.359	.234	.035	.187

**No. 25 • Utica Bent Chain
Nose Pliers**



A 60° angle Bent Chain Nose
simplifies the job of gripping, twisting
and looping fine wire in confined areas.
Designed especially for handling very fine wire.

Cushion Handles, full polish, fine serrated jaws and spring standard.

Old No.	New No.	Dim. A	Dim. B	Dim. C	Dim. E	Wt. ea. lbs.
25-5"	U-16135	1.062	.406	.250	.045	.146

No. 261 • Electronics Short Chain Nose Cutting Pliers

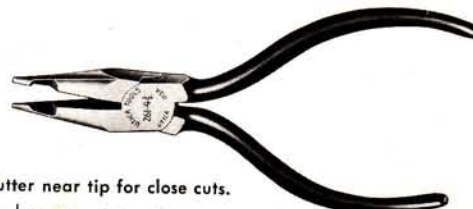

Flush cutter near tip for close cuts.

Old No.	New No.	Dim. A	Dim. B	Dim. C	Dim. D	Wt. ea. lbs.
261-4½"	U-14514	1.062	.438	.281	.188	.146

When ordering, please use new tool number.

No. 265 • Utica Electronics Wiring Pliers with Cutter



Designed for delicate and intricate, sub assembly work. Cushion handles and spring standard.

Old No.	New No.	Dim. A	Dim. B	Dim. C	Dim. D	Wt. ea. lbs.
265-5	U-14855	1.062	.438	.281	.188	.146

No. 622 • Mechanic's Short Chain Nose Side Cutting Pliers



Fed. Spec. GGG-P-00471b
Type XI, Class 2, Style A.
(Milliner's)

Old No.	New No.	Dim. A	Dim. B	Dim. C	Dim. D	Wt. ea. lbs.
622-5"	U-14115	1.190	.500	.313	.375	.230

No. 296 • Electronic Cutting Pliers

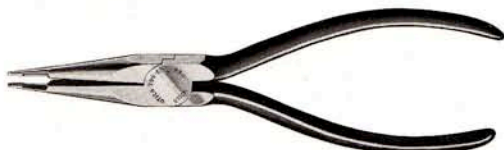

Old No.	New No.	Dim. A	Dim. B	Dim. C	Dim. D	Wt. ea. lbs.
296-6½"	U-14526	1.938	.625	.375	.250	.313

No. 896 • Electronic and Ignition Cutting Pliers

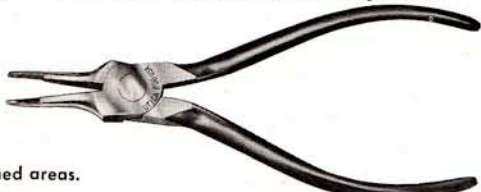

For confined areas.

Old No.	New No.	Dim. A	Dim. B	Dim. C	Dim. D	Wt. ea. lbs.
896-6"	U-14536	1.312	.688	.437	.250	.333

No. 897 • Special Tip Cutting Pliers



Cutter at tip ground flush at an angle for cutting in extremely restricted areas.

Old No.	New No.	Dim. A	Dim. B	Dim. C	Dim. E	Wt. ea. lbs.
897-7"	U-14537	1.594	.660	.406	.040	.354

No. 2291 • Insulation Skinning Pliers



Extensively used in telephone work.

Old No.	New No.	Dim. A	Dim. B	Dim. C	Wt. ea. lbs.
2291-6"	U-16186	1.312	.688	.406	.333

No. 225 • Long Chain Nose Pliers with Crimper



Principally for telephone work. Standard with green plastisol handles.

Old No.	New No.	Dim. A	Dim. B	Dim. C	Dim. E	Wt. ea. lbs.
225-6½"	U-16236	1.875	.625	.375	.093	.333

No. 226 • Long Chain Nose Pliers



Old No.	New No.	Dim. A	Dim. B	Dim. C	Dim. E	Wt. ea. lbs.
226-6½"	U-16226	1.875	.625	.375	.094	.313

No. 227 • Long Chain Nose Pliers



Size of Extreme Point 1/16".

Old No.	New No.	Dim. A	Dim. B	Dim. C	Dim. E	Wt. ea. lbs.
227-6½"	U-16227	1.875	.625	.375	.063	.313

No. 254 • Long Chain Nose Side Cutting Pliers



Fine serrated jaws standard.

Old No.	New No.	Dim. A	Dim. B	Dim. C	Dim. D	Dim. E	Wt. ea. lbs.
254-6½"	U-14226	1.875	.625	.375	.437	.094	.313

NOTE: For other information pertaining to dimensions, refer to Mechanical Drawings, Page 17
When ordering, please use new tool number.

No. 654 • Long Chain Nose Side Cutting Pliers



Fine serrated jaws standard.

Fed. Spec. GGG-P-00471b

Type XI, Class 1, Style A (6" and 7" sizes).

Type XII, Class 2, Style B (6").

Old No.	New No.	Dim. A	Dim. B	Dim. C	Dim. D	Dim. E	Wt. ea. lbs.
654-5 1/2"	U-14215	1.781	.500	.300	.437	.046	.187
6"	U-14216	2.250	.656	.375	.437	.094	.292
7"	U-14217	2.656	.656	.406	.437	.094	.354

No. 926 • Box Joint Long Chain Nose Pliers without Cutters



Fine serrated jaws standard.

Box joint keeps perfect alignment.

Old No.	New No.	Dim. A	Dim. B	Dim. C	Dim. E	Wt. ea. lbs.
926-6"	U-16246	1.844	.562	.375	.094	.292

No. 1033 • Long Chain Nose Pliers



Fed. Spec. GGG-P-00471b

Type XI, Class 1, Style B.

Old No.	New No.	Dim. A	Dim. B	Dim. C	Dim. E	Wt. ea. lbs.
1033-5 1/2"	U-16215	1.781	.500	.300	.046	.187
6"	U-16216	2.250	.656	.375	.094	.292
7"	U-16217	2.672	.656	.406	.094	.354

No. 21 • Round Nose Pliers



Fed. Spec. GGG-P-00471b

4" & 6" sizes - Type X. (Specify scored jaws.)

Scored jaws standard on 5" and 6" sizes.

Plain jaws standard on 4" and 4 1/2" sizes.

Used by radio repairmen, jewelers and opticians.

Old No.	New No.	Dim. A	Dim. B	Dim. C	Dim. E	Wt. ea. lbs.
21-4"	U-16614	.875	.438	.281	.094	.125
4 1/2"	U-16611	1.156	.438	.281	.125	.146
5"	U-16615	1.219	.500	.328	.094	.208
6"	U-16616	1.375	.688	.438	.250	.333

No. 774 • Utica Electronic Pick-up and Wiring Pliers

Cushion Handles, full polish and spring standard.

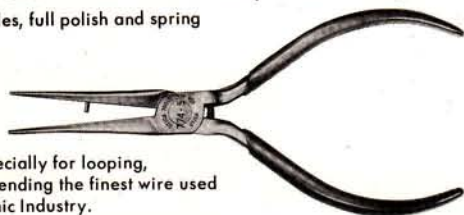

Designed especially for looping, twisting and bending the finest wire used in the Electronic Industry.

Old No.	New No.	Dim. A	Dim. B	Dim. C	Dim. E	Wt. ea. lbs.
774-5 1/2"	U-16585	2.438	.500	.300	.78	.168

No. 775 • Needle Nose Pliers



Fine Nose with strong, stiff jaws.

Old No.	New No.	Dim. A	Dim. B	Dim. C	Dim. E	Wt. ea. lbs.
775-5 1/2"	U-16415	1.750	.500	.250	.050	.144

No. 777 • Long Needle Nose Pliers



For fine electrical and assembly work.

Old No.	New No.	Dim. A	Dim. B	Dim. C	Dim. E	Wt. ea. lbs.
777-6"	U-16516	2.609	.500	.300	.078	.168

No. 778 • Needle Nose Pliers



Strong jaws for firm gripping and looping.

Old No.	New No.	Dim. A	Dim. B	Dim. C	Dim. E	Wt. ea. lbs.
778-6 1/2"	U-16416	1.875	.625	.375	.063	.294

No. 779 • Special Long Needle Nose Pliers

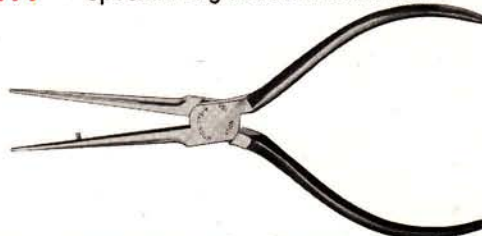

Dowel pin in jaws maintains perfect alignment.

Old No.	New No.	Dim. A	Dim. B	Dim. C	Dim. E	Wt. ea. lbs.
779-6"	U-16586	2.438	.500	.300	.078	.168

No. 776 • Curved Long Needle Nose Pliers



Old No.	New No.	Dim. A	Dim. B	Dim. C	Dim. E	Wt. ea. lbs.
776-6"	U-16526	1.656	.500	.300	.078	.200

When ordering, please use new tool number.

No. 888 • Curved Chain Nose Pliers



Fed. Spec. GGG-P-00471b
Type XII, Class 1.

Old No.	New No.	Dim. A	Dim. B	Dim. C	Wt. ea. lbs.
888-6"	U-16536	1.125	.656	.375	.292

No. 82 • Assembly Pliers, Needle Nose



Fed. Spec. GGG-P-00471b
Type XI, Class 2, Style B.

Used extensively in typewriter repair and assembly work.

Old No.	New No.	Dim. A	Dim. B	Dim. C	Wt. ea. lbs.
82-8"	U-16438	1.375	.562	.438	.396

No. 982 • Box Joint Needle Nose Assembly Pliers



Box joint keeps perfect alignment.

Old No.	New No.	Dim. A	Dim. B	Dim. C	Wt. ea. lbs.
982-8"	U-16428	1.656	.500	.375	.396

No. 63 • Electronic Diagonal Nipper with Curved Handles



Excellent for soft copper or similar material. Jaws set at 22.5° angle. Flush cut edge brought to an extremely fine point.

Old No.	New No.	Dim. A	Dim. B	Dim. C	Wt. ea. lbs.
63-4"	U-15224	.375	.422	.625	.104

No. 64 • Electronic End Cutting Nippers



Full Polish Standard

Jaws set at 22.5° angle. Flush cut edge brought to an extremely fine point. Excellent for very fine electronic work.

Old No.	New No.	Dim. A	Dim. B	Dim. D	Wt. ea. lbs.
64-4"	U-15214	.375	.422	.625	.104

No. 65 • Jewelers' End Cutting Nippers

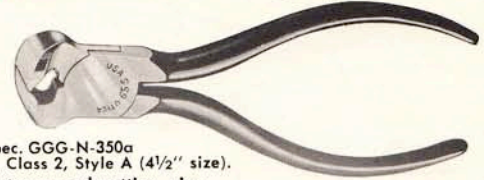

Fed. Spec. GGG-N-350a
Type I, Class 2, Style A (4 1/2" size).

Light, strong end cutting nipper used by jewelers, electricians, opticians and mechanics.

Old No.	New No.	Dim. A	Dim. B	Dim. C	Dim. D	Wt. ea. lbs.
65-4 1/2"	U-15144	.312	.750	.343	.500	.166
5"	U-15145	.375	.906	.312	.750	.208

No. 260 • End Cutting Nippers



Fed. Spec. GGG-N-350a
Type I, Class 2, Style A (6" and 7").

Old No.	New No.	Dim. A	Dim. B	Dim. C	Dim. D	Wt. ea. lbs.
260-6"	U-15116	.375	1.500	.469	1.062	.520
7"	U-15117	.344	1.625	.500	1.188	.708
8"	U-15118	.344	1.750	.531	1.188	.813

No. 360 • High Leverage End Cutting Nippers



Old No.	New No.	Dim. A	Dim. B	Dim. C	Dim. D	Wt. ea. lbs.
360-7"	U-15127	.268	1.250	.594	1.000	.813

No. 262 • Transverse End Cutting Nipper with Semi-Flush Edges



Old No.	New No.	Dim. A	Dim. B	Dim. C	Dim. D	Wt. ea. lbs.
262-5 1/2"	U-15135	1.000	.656	.375	.160	.250

No. 38 • Midget Diagonal Pliers

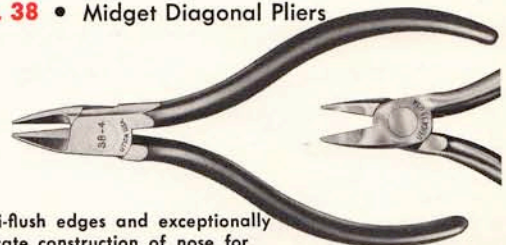

Semi-flush edges and exceptionally delicate construction of nose for precision work.

Old No.	New No.	Dim. A	Dim. B	Dim. C	Wt. ea. lbs.
38-4"	U-13224	.437	.422	.219	.104

NOTE: For other information pertaining to dimensions, refer to Mechanical Drawings, Page 17

When ordering, please use new tool number.

No. 39 • Heavy Duty Diagonal Cutting Pliers



Fed. Spec. GGG-P-00471b
Type IV, Class 1, Style B.

Old No.	New No.	Dim. A	Dim. B	Dim. C	Wt. ea. lbs.
39-7"	U-13137	1.000	.906	.469	.520

No. 43 • Wire Stripping Diagonal Cutting Pliers



Stripping notch for No. 16 Gage
Wire Standard.

The following are available as special order. Type wires: Solid; No. 12 and No. 20 - Stranded; No. 10, 12, 14.

Old No.	New No.	Dim. A	Dim. B	Dim. C	Wt. ea. lbs.
43-5"	U-13435	.781	.625	.375	.250
6"	U-13436	.813	.688	.469	.396

No. 40 • High Leverage Diagonal Cutting Pliers



Fed. Spec. GGG-P-00471b
Type IV, Class 2.

Old No.	New No.	Dim. A	Dim. B	Dim. C	Wt. ea. lbs.
40-7"	U-13447	.800	1.187	.445	.500

No. 44 • Special Diagonal Cutting Pliers

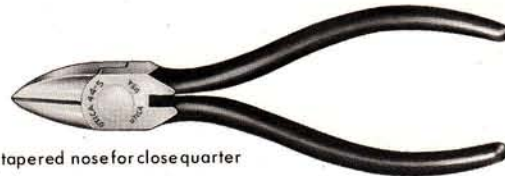

Slim, tapered nose for close quarter
work.

Old No.	New No.	Dim. A	Dim. B	Dim. C	Wt. ea. lbs.
44-5"	U-13145	.750	.625	.375	.250
6"	U-13146	.812	.688	.469	.375

No. 41 • Electrician's Diagonal Pliers



Fed. Spec. GGG-P-00471b
Type IV, Class 1, Style B.

Old No.	New No.	Dim. A	Dim. B	Dim. C	Wt. ea. lbs.
41-4"	U-13114	.656	.563	.344	.187
5"	U-13115	.781	.625	.375	.250
6"	U-13116	.813	.688	.469	.396

No. 45 • Aviation Short Nose Diagonal Cutting Pliers



Fed. Spec. GGG-P-00471b
Type IV, Class 2.

Short nose for greater leverage at tip of cutter.

Old No.	New No.	Dim. A	Dim. B	Dim. C	Wt. ea. lbs.
45-6"	U-13156	.562	.719	.418	.354

No. 41V • Special Diagonal Pliers with "W" Notch and Insulation Crusher

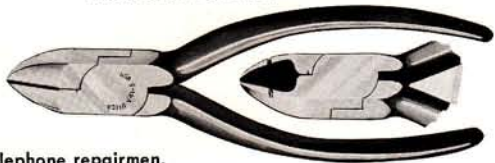

For telephone repairmen.

Old No.	New No.	Dim. A	Dim. B	Dim. C	Wt. ea. lbs.
41-5" V	U-13835	.593	.563	.375	.250

No. 46 • Midget Diagonal Pliers

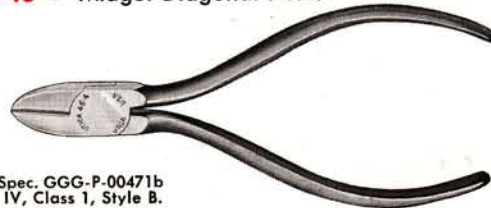

Fed. Spec. GGG-P-00471b
Type IV, Class 1, Style B.

Thin, narrow nose for work in confined areas.

Old No.	New No.	Dim. A	Dim. B	Dim. C	Wt. ea. lbs.
46-4"	U-13214	.500	.422	.218	.125

No. 42 • Diagonal Cutting Pliers with Flush Edges

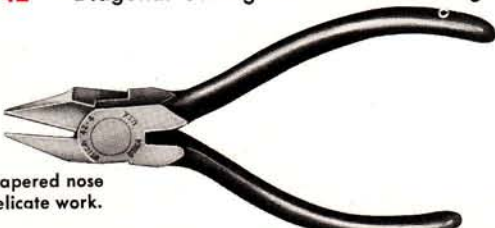

Fine tapered nose
for delicate work.

Old No.	New No.	Dim. A	Dim. B	Dim. C	Wt. ea. lbs.
42-4"	U-13124	.656	.563	.344	.177

No. 34 • Midget (Long Handle) Diagonal Cutting Pliers

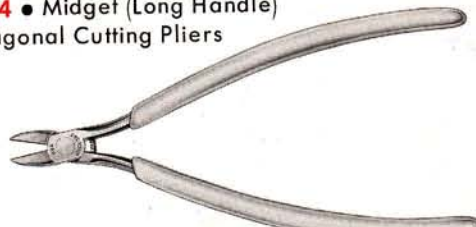

Cushion Handles, Full Polish and Spring Standard. Thin narrow nose and 6" handles make this new Utica diagonal plier ideal for inaccessible areas where long reach and snap cut are required.

Old No.	New No.	Dim. A	Dim. B	Dim. C	Wt. ea. lbs.
34-6"	U-13246	.500	.422	.218	.172

When ordering, please use new tool number.

No. 47 • Midget Diagonal Cutting Pliers with Flush Edges

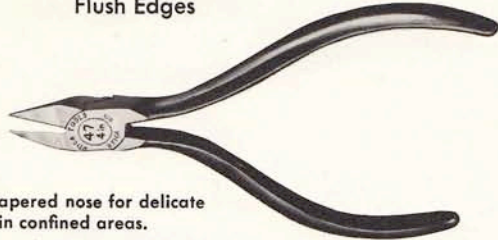

Fine tapered nose for delicate work in confined areas.

Old No.	New No.	Dim. A	Dim. B	Dim. C	Wt. ea. lbs.
47-4"	U-13234	.500	.422	.218	.104

No. 48 • Plastic Cutting Diagonal Pliers



Spring Standard Flush jaws for clean cutting—not for cutting metal.

Old No.	New No.	Dim. A	Dim. B	Dim. C	Wt. ea. lbs.
48-6"	U-13186	.813	.688	.469	.375
7"	U-13187	1.000	.906	.469	.520

No. 49 • Diagonal Cutting Pliers with Semi-Flush Edges



Thin, narrow nose and joint to get into confined areas. Semi-flush edges standard.

Old No.	New No.	Dim. A	Dim. B	Dim. C	Wt. ea. lbs.
49-6"	U-13126	.750	.625	.385	.330

No. 141 • Special Diagonal Cutting Pliers

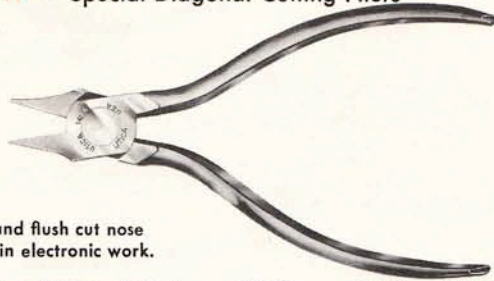

Sharp and flush cut nose for use in electronic work.

Old No.	New No.	Dim. A	Dim. B	Dim. C	Wt. ea. lbs.
141-5"	U-13175	.782	.625	.375	.250
6"	U-13176	.813	.688	.469	.396

No. 146-4 • Diagonal Cutting Pliers with Carbide Edge.

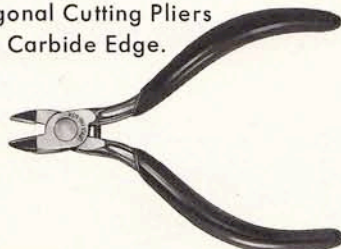

Cushion Handles, Full Polish and Spring Standard. A miniature size wire cutter with carbide inserts at the cutting edges. Designed specifically for the electronic field. Will cut half hard nickel wire.

Old No.	New No.	Dim. A	Dim. B	Dim. C	Wt. ea. lbs.
146-4"	U-13164	.500	.422	.218	.125

No. 241 • Diagonal Cutting Pliers



Old No.	New No.	Dim. A	Dim. B	Dim. C	Wt. ea. lbs.
241-5"	U-13415	.781	.625	.375	.250
5½"	U-13411	.812	.656	.420	.281
6"	U-13416	.812	.718	.420	.350

No. 242 • Diagonal Cutting with Wire Stripping Hole in Blade, Sleeve Grooves or Wire Twisters and with W-Shaped Stripping Notches on back of Head

Size of hole .052" Dia.



Fed. Spec. GGG-P-00471b Type IV, Class 1, Style A (6" size).

Old No.	New No.	Dim. A	Dim. B	Dim. C	Hole Dia.	Wt. ea. lbs.
242-5½"	U-13425	.812	.656	.420	.052	.281
6"	U-13426	.812	.718	.420	.052	.350

No. 441 • Compound Action Diagonal Pliers



With spring.

Old No.	New No.	Dim. A	Dim. B	Dim. C	Wt. ea. lbs.
441-5½"	U-13825	.812	.650	.375	.500

No. 470 • Compound Action Printed Circuit Pliers

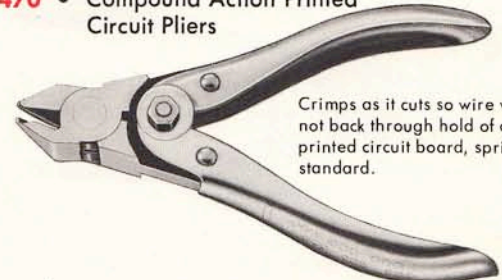

Crimps as it cuts so wire will not back through hold of a printed circuit board, spring standard.

Old No.	New No.	Dim. A	Dim. B	Dim. C	Dim. E	Wt. ea. lbs.
470-5"	U-13845	.500	.650	.420	.078	.354

No. 400 • Parallel Action Pliers

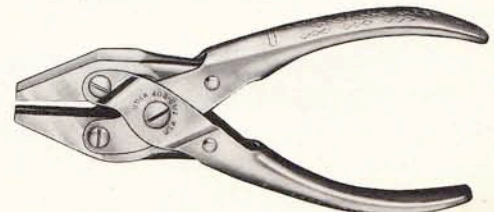

Old No.	New No.	Dim. A	Dim. B	Dim. C	Wt. ea. lbs.
400-6½"	U-18316	1.359	1.156	.375	.542

NOTE: For other information pertaining to dimensions, refer to Mechanical Drawings, Page 17
When ordering, please use new tool number.

No. 402 • Parallel Action Pliers with Cutter

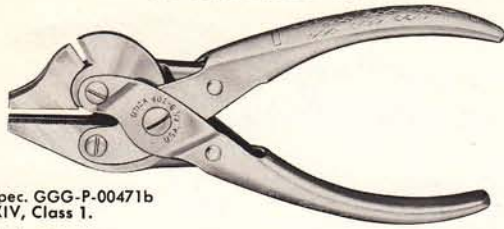

Fed. Spec. GGG-P-00471b
Type XIV, Class 1.

Old No.	New No.	Dim. A	Dim. B	Dim. C	Dim. D	Wt. ea. lbs.
402-6½"	U-18326	1.359	1.562	.375	.390	.542

No. 180 • Button's Pliers for Wire and Steel Mills



Old No.	New No.	Dim. A	Dim. B	Dim. C	Wt. ea. lbs.
180-10"	U-18410	1.500	1.562	.594	1.250

No. 1000 • Giant Button's Pliers



Fed. Spec. GGG-P-00471b
Type III.

Old No.	New No.	Dim. A	Dim. B	Dim. C	Wt. ea. lbs.
1000-8"	U-18428	1.281	1.062	.531	.792
10"	U-18420	1.500	1.312	.594	1.313

No. 2001 • Side Cutting Button's Pliers



Old No.	New No.	Dim. A	Dim. B	Dim. C	Wt. ea. lbs.
2001-8"	U-18438	1.281	1.224	.475	.854

No. 525 • Brake Spring Pliers

No. 525 WS • Brake Spring Pliers with Socket

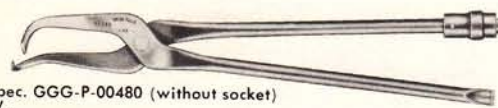

Fed. Spec. GGG-P-00480 (without socket)
Type V.

No. U-19001 - Socket Only.

Old No.	New No.	Dim. A	Dim. B	Dim. C	Wt. ea. lbs.
525-12½"	U-18222	2.843	1.500	.375	.729
525 WS	U-18232				

No. 534 • Lock Ring "Horse Shoe" Pliers



Fed. Spec. GGG-P-00480
Type III, Class 2.
Tips measure ¾" x ¼".

Old No.	New No.	Dim. A	Dim. B	Dim. C	Wt. ea. lbs.
534-7"	U-18117	1.532	.875	.344	.375

No. 535 • Parallel Action Spreading Pliers



For removing automotive snap rings. Maximum opening .938". Forged tips.

Old No.	New No.	Dim. A	Dim. B	Dim. C	Wt. ea. lbs.
535-10"	U-18330	.250	.156	.187	.521

No. 1100 • Fur and Cloth Stretching Pliers

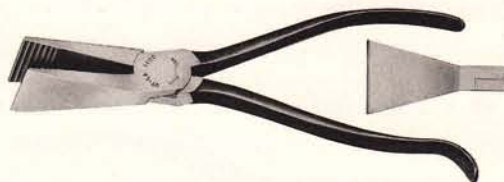

Interlocking teeth are smooth and round to permit stretching fabric without tearing.

Old No.	New No.	Dim. A	Dim. B	Dim. C	Wt. ea. lbs.
1100-7"	U-18807	1.625	.656	1.156	.500

No. 1300 • Gas and Burner Pliers

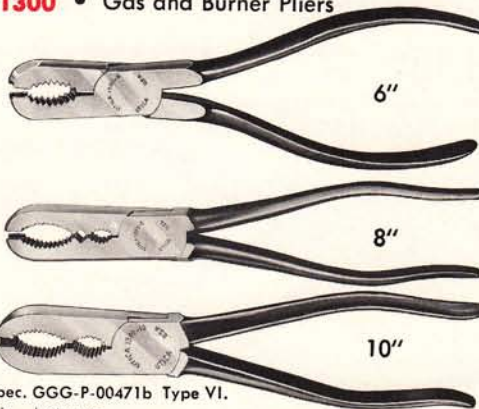

Fed. Spec. GGG-P-00471b Type VI.

Old No.	New No.	Dim. A	Dim. B	Dim. C	Wt. ea. lbs.
1300-6"	U-18516	1.063	.750	.315	.354
8"	U-18518	2.031	.969	.469	.708
10"	U-18510	2.125	1.125	.594	1.042

No. 24-5½ • Lead Seal Press Pliers



One hand operated, Hi-Leverage pliers whose jaws close parallel for a quick complete job. Weight each lbs. .375.

Old No.	New No.
24-5½"	U-18805

When ordering, please use new tool number.

No. 100 • Pocket Armor Cutters

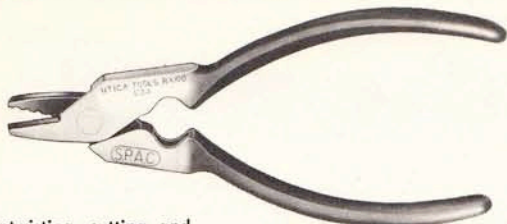

For untwisting, cutting and reclosing BX cable.

Old No.	New No.	Dim. A	Dim. B	Dim. C	Wt. ea. lbs.
100-7"	U-18817	.781	1.094	.375	.500

No. 110 • Wire Stripping Pliers



Spring optional.

Handles up to No. 10 wire. Standard with Red plastisol dipped handles.

Old No.	New No.	Dim. A	Dim. B	Dim. C	Wt. ea. lbs.
110-5"	U-15515	.625	.625	.170	.164

No. 750 • Angle Locknut Pliers

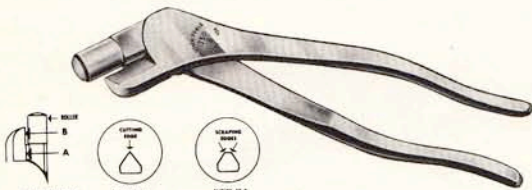

Tightens locknuts in electrical outlet boxes, removes burrs from conduit or pipe, cuts and skins rubber covered wire. Tool measures 8".

Old No.	New No.
No. 750 - 8"	U-18808

No. 818 Spring Manufacturers' and Body Trimmers' Hog Ring Pliers

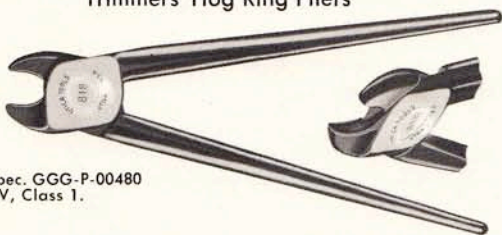

Fed. Spec. GGG-P-00480 Type IV, Class 1.

Old No.	New No.	Dim. A	Dim. B	Dim. C	Dim. E	Wt. ea. lbs.
818-7"	U-18527	.468	1.031	.312	.185	.479

No. 819 • Bent Hog Ring Pliers

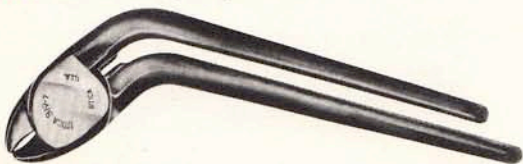

Used by upholsterers, particularly automotive. (Standard with 45° angle.)

Old No.	New No.	Dim. A	Dim. B	Dim. C	Wt. ea. lbs.
819-7"	U-18537	.516	1.031	.312	.479

No. 820 • Bent Hog Ring Pliers



Used by upholsterers, particularly automotive. Handles bent at 45°.

Old No.	New No.	Dim. A	Dim. B	Dim. C	Wt. ea. lbs.
820-7"	U-18547	.516	1.031	.312	.479

No. 1932 • Original Utica Fence Pliers and Staple Puller



Fed. Spec. GGG-P-00471b Type XVI.

Old No.	New No.	Dim. A	Dim. B	Dim. C	Wt. ea. lbs.
1932-10"	U-18610	.750	3.000	.550	1.354

No. 1933 • Fence Pliers — Two Hammer Heads



Old No.	New No.	Dim. A	Dim. B	Dim. C	Wt. ea. lbs.
1933-10"	U-18620	.750	2.125	.550	1.354

No. 270 • Straight Cut Tin Snips



Fed. Spec. GGG-S-291C 7" and 12" sizes — Type II, Class A, Grade B.

Old No.	New No.	Dim. A	Dim. B	Dim. C	Wt. ea. lbs.
270-7"	U-15317	2.000	1.219	.500	.500
10"	U-15310	2.375	1.469	.689	1.000
12"	U-15312	2.969	1.625	.719	1.750

No. 275 • Circular Cut Tin Snips



Fed. Spec. GGG-S-291C 7" and 12" sizes, Type II, Class C, Grade B.

Old No.	New No.	Dim. A	Dim. B	Dim. C	Wt. ea. lbs.
275-7"	U-15327	1.688	.906	.781	.500
10"	U-15320	2.281	1.156	.969	1.000
12"	U-15322	3.125	1.188	1.344	1.750

NOTE: For other information pertaining to dimensions, refer to Mechanical Drawings, Page 17. When ordering, please use new tool number.

No. 272 • Electronic Snips—Long Blades
No. 273 • Electronic Snips—Short Blades

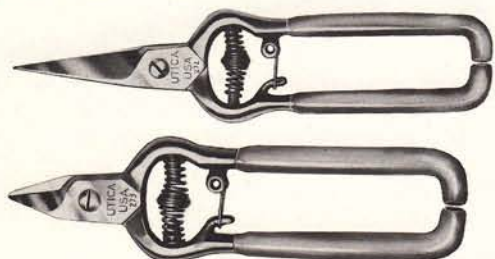

Shear action of the pointed blades cuts filament, fine wire and other electronic materials. Standard with spring and plastisol dipped handles.

Old No.	New No.	Dim. A	Dim. B	Dim. C	Wt. ea. lbs.
272—7½"	U-15347	2.000	.625	.359	.406
273—6½"	U-15346	.750	.625	.359	.390

No. 280 • Aviation Type Snips—Cuts Left
No. 281 • Aviation Type Snips—Cuts Right
No. 282 • Aviation Type Snips—Cuts Straight



Fed. Spec. GGG-S-291C
 280—Type II, Class D, Design 3, Grade A.
 281—Type II, Class D, Design 2, Grade A.
 282—Type II, Class D, Design 1, Grade A.

Compound leverage for easy cutting of metals up to 18 gauge. Length 10", weight ea. lbs. 1.01. Standard with plastisol dipped handles. Color coded: yellow/cuts straight, red/cuts right, green/cuts left.

Old No.	New No.	Dim. A	Dim. B	Dim. C	Wt. ea. lbs.
280—10"	U-15360	1.437	1.000	.687	1.01
281—10"	U-15350	1.437	1.000	.687	1.01
282—10"	U-15370	1.437	1.000	.687	1.01

No. 101 • Midget Pliers-Snips

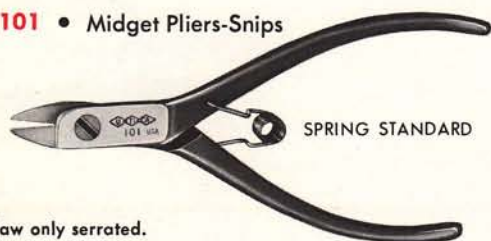

SPRING STANDARD

One jaw only serrated.

Old No.	New No.	Dim. A	Dim. B	Dim. C	Wt. ea. lbs.
101—4½"	U-15414	.453	.400	.187	.125

No. 20820 • Chipping Knife

Fed. Spec. GGG-K-481a Type III.



For splitting lead cable. Used in telephone work. Overall length 9", blade length 4¾". Weight each lbs. 1.080.

Old No.	New No.
20820—9"	U-20820

No. 20821 • Chipping Knife



Fed. Spec. GGG-K-481a Type VI.
 For splitting lead cable. Used in telephone work. Has hammer head on back of blade. Overall length 7¼", blade length 2½". Weight each lbs. .417.

Old No.	New No.
20821	U-20821

No. 561 • Retaining Ring Pliers



Fed. Spec. GGG-P-00480 Type I, Class 1, Style A.

For internal rings.

Old No.	New No.	Dim. A	Dim. B	Dim. D	Dim. E	Dim. F	Dim. H	Wt. ea. lbs.
561—6"	U-18116	5.438	1.875	.750	.688	.038	1.688	.190

No. 562 • Retaining Ring Pliers



Fed. Spec. GGG-P-00480 Type II, Class 2, Style A.

For external rings.

Old No.	New No.	Dim. A	Dim. B	Dim. D	Dim. E	Dim. F	Dim. H	Wt. ea. lbs.
562—6"	U-18126	5.688	2.188	1.000	.766	.038	2.250	.190

No. U-84001 • Snap Ring Plier Set

Consists of an external and internal plier and an interchangeable tip set.



Tip set contains the following in a plastic box:

REPLACEMENT PARTS	
U-84001-1	Internal Plier
U-84001-2	External Plier
U-84001-3	Interchangeable Tip Set
	2 Prs. of 90°, .035 Dia. Tips.
	2 Prs. of 45°, .045 Dia. Tips.
	2 Prs. of Straight Tips, .045 Dia.
	2 Prs. of Straight Tips, .060 Dia.

When ordering, please use new tool number.

UTICA TOOLS

Use Utica and do the job with industry's finest quality hand tools . . . the tools preferred by expert mechanics and craftsmen. Utica pliers and wrenches are drop-forged for rugged durability! Induction hardened at the points of greatest wear—jaws and cutting edges—for extra strength! Extra long life! And like all Utica hand tools, they are backed by famous full guarantee.

Reference Drawings for Tool Dimensions

These drawings furnish the key to listed dimensions which are all subject to standard commercial tolerances.

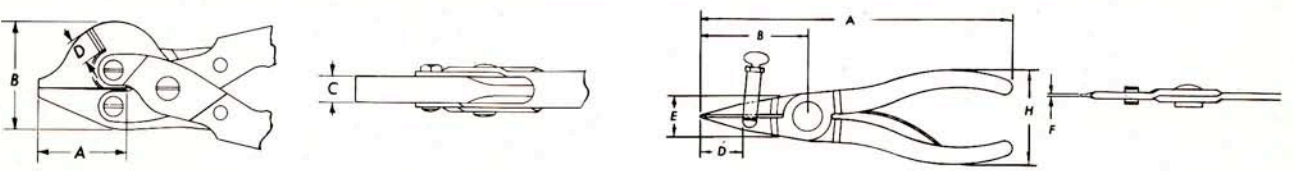
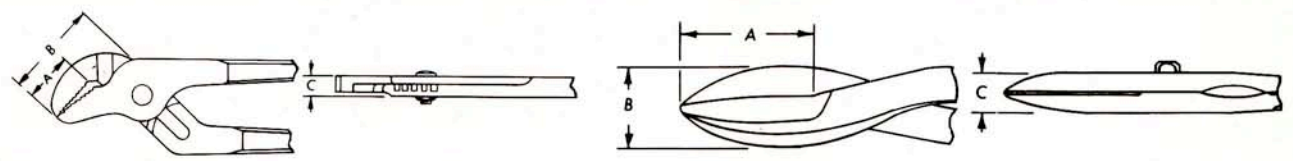
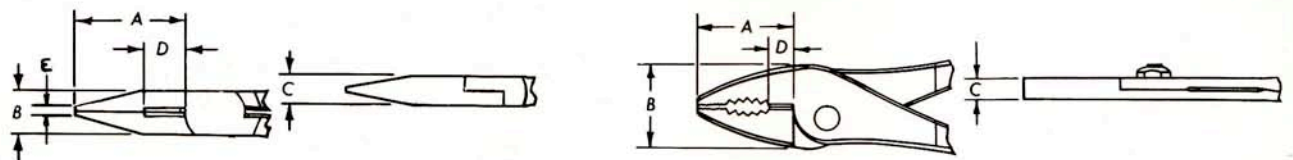
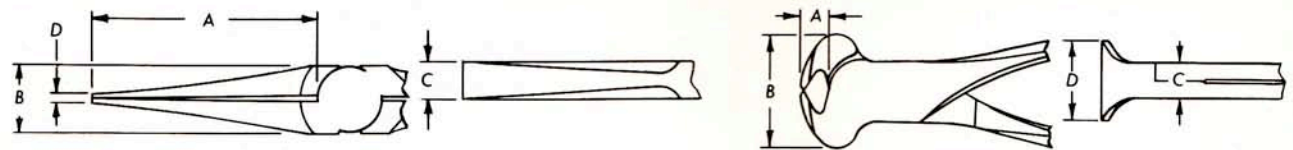
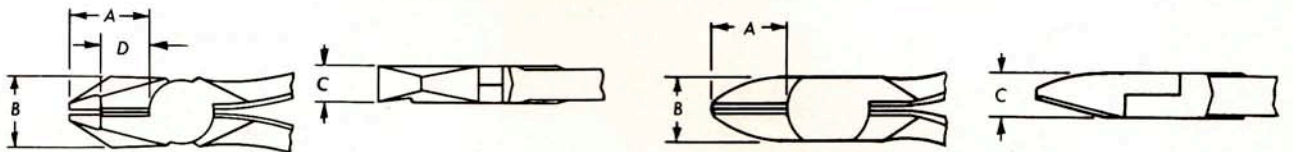

NEW FROM UTICA!



SKIN-PACKAGED HAND-TOOLS ILLUSTRATED ABOVE ARE AS FOLLOWS:

TOOL NO.	SKIN-PAK NO.
50-6"	SP U-14616-80
91-4"	SP U-21041-80
91-8"	SP U-21081-80
260-7"	SP U-15117-80
507-6 1/2"	SP U-12236-80
1033-6"	SP U-16216-80

OTHER SKIN-PACKAGED TOOLS AVAILABLE FROM STOCK NOT ILLUSTRATED ABOVE ARE LISTED AS FOLLOWS:

TOOL NO.	SKIN-PAK NO.
8-6"	SP U-11136-80
8-8"	SP U-11138-80
23-4 1/2"	SP U-16121-80
40-7"	SP U-13447-80
41-5"	SP U-13115-80
41-6"	SP U-13116-80
46-4"	SP U-13214-80
50-8"	SP U-14618-80
91-6"	SP U-21061-80
91-10"	SP U-21101-80
507-10"	SP U-12230-80
654-6"	SP U-14216-80
654-7"	SP U-14217-80
1950-8"	SP U-14458-80

**SKIN-PACKAGED
HAND-TOOLS
ESPECIALLY DESIGNED
FOR GREATER
CUSTOMER INTEREST,
FASTER TURNOVER
AND PROFITS FOR YOU**

Please use SKIN-PAK NO. when ordering . . .

Electronics by **UTICA**

Electronically
Induction-Hardened
Cutting Edges

Old No.
44-5 CFS
New No.
U-13145-22
Semi-
Flush
Edge

Hand Honed
Edges

Old No.
38-4 CFS
New No.
U-13224-22
Semi-Flush Edge

Coil Springs

Old No.
47-4 CFS
New No.
U-13234-22
Flush Edge

**NOT JUST
A TOOL...
BUT AN
INSTRUMENT**

These Electronic Tools are designed specifically for the Electronic Industry and are available only with the specified special features. However, if other features or a combination of features are desired please refer to the parent tool illustrated in the regular Utica line.

Old No.
42-4 CFS
New No.
U-13124-22
Flush Edge

Precision
Joints

Old No.
46-4 CFS
New No.
U-13214-22
Semi-Flush
Edge

Full Polished

Old No.
49-6 CFS
New No.
U-13126-22
Semi-Flush Edge

Cushion Grip
Handles

UTICA TOOL CO., INC.

Subsidiary  The Triangle Corporation
Orangeburg, South Carolina 29115



ELECTRONICS—Continued

No. 146 • Utica Carbide Edge Wire Cutting Tool



Cushion Handles, Full Polish and Spring Standard. A miniature size wire cutter with carbide inserts at the cutting edges. Designed specifically for the electronic field. Will cut half hard nickel wire.

Old No.	New No.	Dim. A	Dim. B	Dim. C	Wt. ea. lbs.
146-4"	U-13164	.500	.422	.218	.125

No. 34 • Midget (Long Handle) Diagonal Cutting Pliers



Cushion Handles, Full Polish and Spring Standard. Thin narrow nose and 6° handles make this new Utica diagonal plier ideal for inaccessible areas where long reach and snap cut are required.

Old No.	New No.	Dim. A	Dim. B	Dim. C	Wt. ea. lbs.
34-6"	U-13246	.500	.422	.218	.172

No. 64CS • Electronic Diagonal Nippers



Jaws set at 22.5° angle. Flush cut edge brought to an extremely fine point. Excellent for very fine electronic work. With full polish, cushion handles and spring.

Old No.	New No.	Dim. A	Dim. B	Dim. D	Wt. ea. lbs.
64-4"CS	U-15214-11	.375	.422	.625	.104

No. 265 • Utica Electronics Wiring Pliers with Cutter



Cushion Handles and Spring Standard. For delicate and intricate sub assembly work. Used for cutting, looping, and twisting solid or standard wire.

Old No.	New No.	Dim. A	Dim. B	Dim. C	Dim. D	Wt. ea. lbs.
265-5"	U-14855	1.062	.438	.281	.188	.146

No. 896CFS • Electronic and Ignition Cutting Pliers



With cushion handles, full polish and spring. For confined areas.

Old No.	New No.	Dim. A	Dim. B	Dim. C	Dim. D	Wt. ea. lbs.
896-6"CFS	U-14536-22	1.312	.688	.437	.250	.333

No. 654 CFS • Long Chain Nose Side Cutting Pliers



With cushion handles, full polish and spring. Spring-tempered, serrated jaws with extra-hardened jaw surfaces. Cutters extra-hardened and hand-honed. Long reach, grabs small parts easily.

Old No.	New No.	Dim. A	Dim. B	Dim. C	Dim. D	Dim. E	Wt. ea. lbs.
654-5½"CFS	U-14215-22	1.781	.500	.300	.437	.046	.187

No. 1033 CFGRS • Long Chain Nose Pliers



With Radius Edges, spring, cushion handles, full polish, and smooth jaws. Spring-tempered jaws for solid grip on small inaccessible objects.

Old No.	New No.	Dim. A	Dim. B	Dim. C	Dim. D	Wt. ea. lbs.
1033-5½"CFGRS	U-16215-58	1.781	.500	.300	.046	.187

No. 774 GR • Utica Electronic Pick-Up and Wiring Pliers

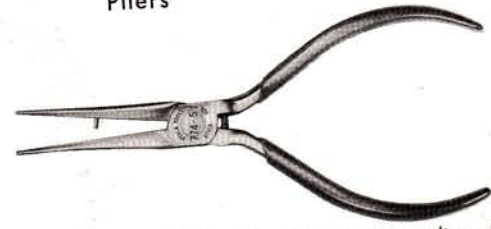

With Cushion handles. Full polish, unscored jaws, radius edges and spring. Designed especially for looping, twisting, bending, and picking up the finest wire used in the electronic industry. Dowel pin holds jaws in perfect alignment.

Old No.	New No.	Dim. A	Dim. B	Dim. C	Dim. E	Wt. ea. lbs.
774-5½"GR	U-16585-43	2.438	.500	.300	.78	.168

When ordering, please use new tool number.



ELECTRONICS—Continued

No. 25GR Utica Bent Chain Nose Pliers



With unscored jaws, Cushion handles, Full polish, Radius Edges & Spring A 60° angle bent chain nose simplifies the job of gripping, twisting, and looping fine wire in confined areas.

Designed especially for handling very fine wire.

Old No.	New No.	Dim. A	Dim. B	Dim. C	Dim. E	Wt. ea. lbs.
25-5*GR	U-16135-43	1.062	.406	.250	.045	.146

No. 23 GR • Short Chain Nose Pliers

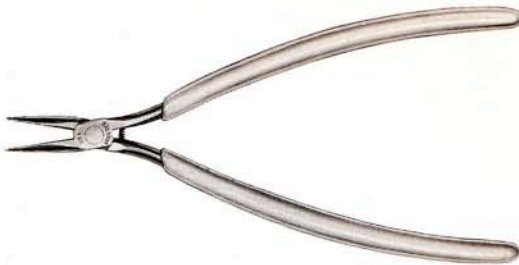

With Cushion handles. Full polish, unscored jaws, radius edges and spring. Designed especially for looping, twisting, bending, and picking up the finest wire used in the electronic industry.

Old No.	New No.	Dim. A	Dim. B	Dim. C	Dim. E	Wt. ea. lbs.
23-6*GR	U-16126-43	.843	.359	.234	.035	.187

No. UA-100 • Power Cutter



Designed for high-volume production. Air-activated diagonal head wire cutter has full length trigger for right or left hand cutting.

Old No.	New No.	Wt. ea. lbs.
UA-100	U-18910	6 1/4 oz.

No. U-75271 — Diagonal Cutting Head Standard.

No. UA-200B5 • Utica Multi-Purpose Power Cutter



8" Hose and 1/8" Pipe Fittings. An air-activated high-power cutting tool available with a choice of four interchangeable heads. B-5 — Cutter standard edge diagonal cutting head.

Old No.	New No.	Wt. ea. lbs.
UA-200B5	U-18925	7-3/4 oz.

No. U-18920 — Power Tool without Cutting Head.

No. UA-200 • Optional Heads for Varied Uses



Old No.	New No.
UA-200B-6	U-18926

Cutter Hairline flush edge diagonal cutting head.

Old No.	New No.
UA-200B-7	U-18927

Cutter Crimper head for printed circuits.

Old No.	New No.
UA-200B-8	U-18928

Diagonal cutting head for plastics only.

See Price List for Optional Heads only.

No. UA-300 • Utica Power Writer



For fast easy marking of tools and parts. Air-activated Power Writer for marking all types of materials such as metals, plastics, ceramics, and glass. No special skill required.

Old No.	New No.	Wt. ea. lbs.
UA-300	U-18930	5-1/4 oz.

No. U-86101 — Tip Replacement (3 per box).

No. SW-1 • Utica Stripwright Wire Strippers

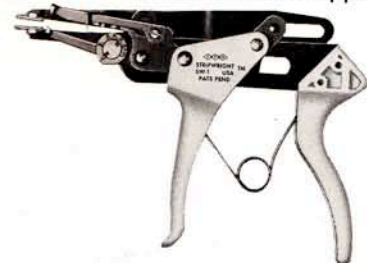

Precision-built to prevent wire nicking cam action calibrated dial adjusts to strip from No. 12 to No. 26 wire gauge size, with a full range from .0" to .080".

Old No.	New No.	Wt. ea. lbs.
SW-1	U-18801	7 oz.

Old No.	New No.
SW-1L	U-18802

— Stripwright equipped with adjustable positive lock for desired wire gauge (extra cost).

No. U-18801-32 Adjustable stop extension for short length stripping, 1/8" minimum available at no extra cost.

UTICA is adding new pliers as fast as they can be engineered in order to keep pace with the ever increasing demands of the Electronics Industry for specialized tools. Please send us your specifications and/or requirements and our **NEW CUSTOM TOOL SHOP** will be glad to assist you.

NOTE: For other information pertaining to dimensions, refer to Mechanical Drawings, Page 17

When ordering, please use new tool number.



CUSTOM PLIERS

Old No. | New No.
No. B5316-4" | **U-75316** • Diagonal Cutting Pliers



Designed for close cutting on circuit boards or chassis assemblies, with a fine tapered nose for delicate work. Cushion handles, flush edges and spring standard.

Old No. | New No.
No. B5318-5 1/2" | **U-75318** • Needle Nose Pliers



Designed for fine electrical and assembly work. Will not mark soft wire. Cushion handles, smooth jaws with radius edges and spring standard.

Old No. | New No.
No. B5317-5" | **U-75317** • Thin Chain Nose Pliers

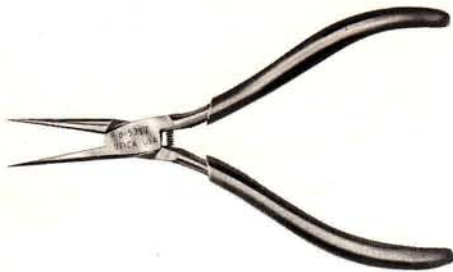

Designed for subminiature work. Will not mark soft wire. Cushion handles, smooth jaws with radius edges and spring standard.

Old No. | New No.
No. B5263-4" | **U-75263** • Midget Diagonal Pliers



Designed with thin, narrow nose for work in confined areas. Cushion handles, full polish, flush cutting edge and spring standard.

* SEE CUSTOM BUILT PLIERS, PAGE 24, OF THIS CATALOG FOR FURTHER INFORMATION ON CUSTOM PLIERS.

RAPID-WRAPIT TOOLS *

No. RW-100 • Utica Rapid-Wrapit Tool

*TRADE MARK

Wire Gauge
 26
 24
 22

Sleeve Part No.

Old No.	New No.
RS 264	U-19164
RS 244	U-19144
RS 224	U-19124

Bit Part No.

Old No.	New No.
RB 261	U-19061
RB 241	U-19041
RB 221	U-19021



Hand Operated tool for solderless wrapped wire connections. Bits and sleeves are required.

Old No. | New No.

RW-100 | U-18821 Wt. 10-1/2 oz.
 RW-200 | U-18822 - With Collet Chuck

A light, hand operated tool suitable for either production line or field work. Housing is aluminum with nickel-chrome finish. (Weight 10-1/2 oz.)

BITS



Different bits are required, depending on the size of the wire, the size of the terminal and height on the terminal at which the connection is to be made. Wire and terminal specifications for bits are set forth in the tables below.

SLEEVES



Different sleeves are required depending on the size of the wire and the terminal. Utica Rapid-Wrapit sleeves are insulated and minimize shorting to adjacent terminals. There is, however, no insulation from the terminal and the connection being wrapped. See tables below for selection of proper sleeve size.

TERMINAL DIMENSIONS



Wire Gauge Size	Sleeve Part Number	Bit Part Number	Wire Size Dia. of Bit	TERMINAL SPECIFICATIONS											
				"Vee"						Square					
				Max.	Min.	Sec.	Rectangular			Max.	Min.	Sec.	Max.	Min.	
				A	B	X	Y	Z	X	Y	C	D	E	F	
26	RS 264	RB 261	.075	.070	.010	.062	.031	.062	.040	.070	.040	.012	.045	.045	.030
24	RS 244	RB 241	.075	.070	.010	.062	.031	.062	.040	.070	.040	.012	.045	.045	.030
22	RS 224	RB 221	.087	.082	.012	.062	.031	.062	.058	.082	.062	.015	.045	.058	.035

BIT SPECIFICATIONS

Wire Gauge No.	Bit Part No.	Bore		Z	A	Wire Gauge No.	Sleeve Part No.
		X	Y				
26	RB 261	.075	.800	2"	.162	26	RS 264
24	RB 241	.075	.800	2"	.162	24	RS 244
22	RB 221	.087	.800	1 1/4"	.190	22	RS 224

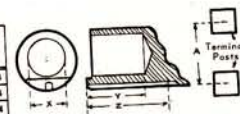

UTICA TOOL CO., INC.

Subsidiary of The Triangle Corporation
 Orangeburg, South Carolina 29115

A perfected locking adjustable wrench

SELECT-O-LOCK

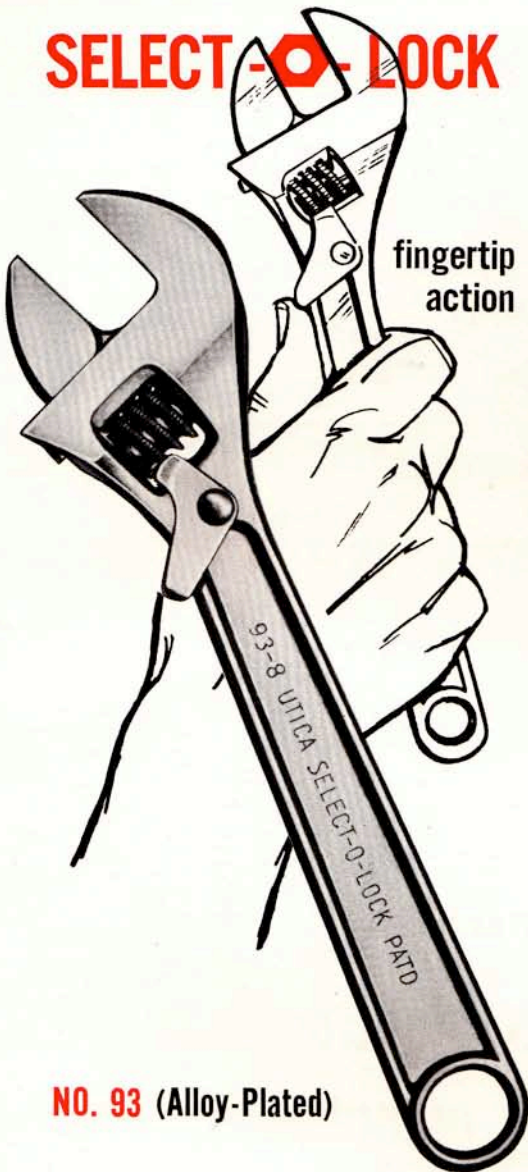

fingertip action

NO. 93 (Alloy-Plated)

Locking adjustable wrench... SELECT-O-LOCK®. Operates with finger tip action. Positive lock in any position.

Developed by Utica

Avoid slipping or resetting with the new, perfected Select-O-Lock adjustable wrench. Simple thumb action locks jaws at any desired setting, yet the Select-O-Lock wrench retains the characteristic strength and ruggedness of regular Utica adjustable wrenches. The locking device is positioned for easy manipulation; rivet-fastened for long life and smooth action. Induction hardened jaws with all parts interchangeable with regular adjustable wrenches.

Can be ordered in series No. 93 (Plated-finish alloy steel) and series No. 94 (black-finish alloy steel).

Adjustable wrenches

All wrench jaws are induction hardened for longer wear



NO. 91 (Alloy-Plated)

Thin jaws to reach difficult spots. Drop forged from tough Alloy Steel to withstand rigorous breakage tests

Fed. Spec. GGG-W-631a Type I



NO. 90 (Alloy-Black)

Identical in pattern to No. 91 series. With black finish.

NO. 94 (Alloy-Black)

Identical in pattern to No. 93 series with black finish.

SPECIFICATIONS

Size	Jaw Open	Thickness of Head Tip of Jaw	Thickness of Head Thickest Part	Wt. Ea. Lbs.
	Maximum not less than	Minimum	Minimum	
4"	.510	.136	.335	.109
6"	.760	.197	.383	.297
8"	.947	.203	.445	.437
10"	1.135	.331	.610	.813
12"	1.322	.379	.705	1.468
15"	1.698	.528	.949	2.875
18"				



THIN PATTERN DESIGN

Note the thin jaws, handles. They meet rigid strength requirements.

OLD NO.	NEW NO.	OLD NO.	NEW NO.
90-4	U-21040	91-4	U-21041
90-6	U-21060	91-6	U-21061
90-8	U-21080	91-8	U-21081
90-10	U-21100	91-10	U-21101
90-12	U-21120	91-12	U-21121
90-15	U-21150	91-15	U-21151
90-18	U-21180	91-18	U-21181

OLD NO.	NEW NO.	OLD NO.	NEW NO.
93-4	U-21043	94-4	U-21042
93-6	U-21063	94-6	U-21062
93-8	U-21083	94-8	U-21082
93-10	U-21103	94-10	U-21102
93-12	U-21123	94-12	U-21122

Adjustable Wrench Repair Parts Kit W-2 U-86203

Although replacements are infrequently needed, the following assortment of wrench repair parts has been chosen with our experience of the parts called for. Packed in a sturdy box.

The assortment is:

	Jaws	Knurls	Pins	Springs
4"	2	2	2	2
6"	3	4	4	4
8"	3	4	4	4
10"	2	2	2	2
12"	1	2	2	2

"All Utica Tools are made of fine alloy steel. Great care is given to the heat treating and processing of this steel. The careful control we exercise over the production steps in our process insures a uniformly high quality in the finished tools".

● custom built pliers

Production and assembly problems frequently can be solved by the use of a special tool. Whether a completely new tool is needed or merely the modification of a standard one, UTICA'S experience and long line of basic pliers will usually provide a solution. Write the Sales Department for further information.



● forged tools are best

Drop forging gives the metal a "grain flow" much like the grain in wood. Drop forged tools are thus stronger than castings or stampings.

CASTING

STAMPING

FORGING

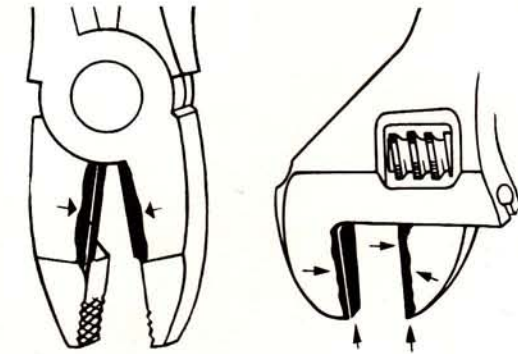

● electronically induction hardened jaws & cutting edges

By a unique process of electronic induction hardening, Utica gives longer life to the working surfaces of its tools. This is a selective hardening, leaving the rest of the tool resilient and tough.

**HARDENED PATTERN
ILLUSTRATIONS ABOVE SHOW INDUCTION**



U-90004 thru U-90012



U-90022 thru U-90026



U-90043 thru U-90050



U-90093 thru U-90099



U-90061 - U-90062

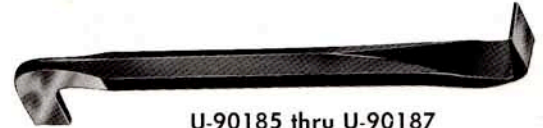

U-90185 thru U-90187



U-90074 thru U-90082

SCREW DRIVERS

Standard Tip, Thin Blade, Electrical, Stubby & Offset

UTICA's screw drivers are available in either tough, shockproof plastic or turned hardwood handles. All handles are oversized and shaped for comfortable,

STANDARD TIP, PLASTIC HANDLE

This popular series has a round, one piece forged blade fitted into a man-sized handle. An upset bolster insures extra tight fit and prevents forcing blade into handle.

Number	Blade Length	Tip Width	Shank Diameter	O.A. Length	Weight Lbs.
*U-90004	4	1/4	1/4	7 3/4	.191
*U-90006	6	3/16	5/16	10 1/2	.322
*U-90008	8	3/8	3/8	13	.500
*U-90010	10	7/16	7/16	15	.681
*U-90012	12	3/8	3/8	17 1/2	.831

THIN BLADE, Round Shank, Electrical, Radio, Plastic Handle

*U-90022	2	1/8	1/8	4 5/16	.025
*U-90023	3	1/8	1/8	6	.028
*U-90025	5	1/8	1/8	6	.041
*U-90026	6	1/8	1/8	9	.044

Note: No. U-90022 has pocket clip.

ELECTRICAL-RADIO, CABINET, PLASTIC HANDLE

Round blade with bolster.

*U-90043	3	3/16	3/16	6 3/16	.094
*U-90046	6	3/16	3/16	9 3/8	.138
*U-90050	10	3/16	3/16	13 3/8	.166

STANDARD TIP, STUBBY, PLASTIC HANDLE

*U-90061	1	1/4	7/32	2 3/4	.050
*U-90062	1 3/4	1/4	1/4	3 3/4	.116

maximum torque grip. Blades are made from high alloy steel, accurately ground and tempered for maximum strength. Polished full length.

HEAVY-DUTY, STANDARD TIP, Square Blade, Plastic Handle.

High alloy steel, forged blade, carefully tempered for heavy-duty service. Shockproof, comfort grip plastic handle fitted to forged bolster to prevent driving blade through handle.

Number	Blade Length	Tip Width	Shank Diameter	O.A. Length	Weight Lbs.
*U-90074	4	5/16	7/32	7 3/4	.213
*U-90075	5	5/16	9/32	9 1/4	.240
*U-90076	6	3/8	5/16	10 1/4	.378
*U-90078	8	7/16	3/8	12 3/4	.569
*U-90080	10	3/8	11/32	15 1/2	.588
*U-90082	12	1/2	3/8	17 1/2	.800

STANDARD TIP, Round Blade, Bolster Type, Wood Handle

*U-90093	3	1/4	7/32	7 1/2	.153
*U-90094	3 3/4	1/4	1/4	9	.194
*U-90096	5 11/16	9/32	5/16	11 7/8	.331
*U-90098	8	3/8	3/8	14 7/16	.525
*U-90099	10	3/8	3/8	16 5/16	.588

OFFSET

For close quarter work, these offset screw drivers are excellent where obstructions prevent use of standard screw drivers.

Number	O.A. Length	Tip Width	Weight Lbs.
*U-90185	4 7/8	1/4	.063
*U-90186	5 3/8	3/16	.125
*U-90187	5 7/8	3/8	.250

* Denotes not guaranteed against breakage nor wear, but are guaranteed against defects in material or workmanship.



U-90141 thru U-90144



U-90171 - U-90172



U-90151 - U-90152



U-90161 thru U-90164



U-90123 thru U-90127



U-90121 - U-90122



U-90032 thru U-90035



U-90131 thru U-90135

UTICA TOOLS

SCREW DRIVERS AND SETS

PHILLIPS TYPE, PLASTIC HANDLE

Blades of forged, heat tempered alloy steel—shockproof, comfort grip plastic handles.

Number	Phillips Bit	Blade Length	Blade Diameter	O.A. Length	Weight Lbs.
U-90141	#1	3	3/16	6	.063
U-90142	#2	4	1/4	7 3/4	.125
U-90143	#3	6	3/16	10 1/4	.375
U-90144	#4	8	3/8	12 1/2	.500
U-90151 (Stubby) #1	#1	1	3/16	2 3/4	.100
U-90152 (Stubby) #2	#2	1 1/2	1/4	3 1/2	.118

PHILLIPS TYPE, WOOD HANDLE

U-90161	#1	3	3/16	6 1/4	.075
U-90162	#2	4	1/4	8 3/4	.141
U-90163	#3	6	3/16	11	.294
U-90164	#4	8	3/8	14 1/2	.519
U-90171 (Stubby) #1	#1	1	3/16	2 7/8	.044
U-90172 (Stubby) #2	#2	1 3/8	1/4	3 3/8	.088

THIN BLADE, Square Shank, Electrical, Radio, Plastic Handle

The screw driver preferred by mechanics. Selected alloy steel with bits forged with the square (not cross square) for greater grain refinement of the steel providing toughness and added strength. Careful hardening processes provide long wear and resiliency. Bits accurately ground for perfect non-lift grip when used on proper size screw. Handles are designed and shaped for comfortable, high-torque, non-slip grip.

Number	Bit Width	Blade Length	Size Square Stock	Wt. Lbs. 10 Pcs.
U-90032	1/8	2	1/8	3/8
U-90033	1/8	3	1/8	3/8
U-90035	1/8	5 3/4	1/8	9/16

CLUTCH HEAD, PLASTIC HANDLE

This series is of the popular butterfly design (Type G) for clutch head screws.

Number	Bit Size	Blade Length	Shank Diameter	O.A. Length	Weight Lbs.
U-90121 (Stubby) #1	3/32	1 3/4	1/4	3 7/8	.128
U-90122 (Stubby) #2	1/4	1 3/4	1/4	3 7/8	.125
U-90123	3/32	4	1/4	7 1/2	.156
U-90125	1/4	6	3/16	10 1/4	.313
U-90126	3/32	6 3/8	3/16	10 3/8	.306
U-90127	5/16	6	3/8	10 7/8	.450

Set No. U-84203 (5 Pieces Packed in Cardboard Container - 1.500 lbs.) consisting of Clutch Heads No. U-90123, U-90125, U-90127, U-90121, U-90122.

Set No. U-84204 (4 Pieces Packed in Cardboard Container - 1.250 lbs.) consisting of Phillips No. U-90141, U-90142, U-90143, U-90144.

Set No. U-84209 (5 Pieces Packed in Cardboard Container - 2.250 lbs.) consisting of Standard Wood Handle Screw Drivers No. U-90093, U-90094, U-90096, U-90098, U-90099.

Set No. U-84302 (3 Pieces Packed in Cardboard Container - .470 lbs.) consisting of Offsets No. U-90185, U-90186, U-90187.

HEX BOLSTER (Slot Type)

Built for heavy duty use. Forged hex bolster on shank for wrenching on tough jobs. Special alloy steel precision forged and ground for accurate fit. Blades full polished entire length.

Number	Bit Width	Blade Length	Bolster Across Flats	Wt. Lbs. 10 Pcs.
U-90131	1/4	4 7/8	1/2	3 1/4
U-90132	3/16	6	1/2	3 3/8
U-90133	3/8	7	9/16	4 3/4
U-90134	3/8	8 7/8	9/16	5 13/16
U-90135	7/16	11	9/16	6 3/16

*Denotes not guaranteed against breakage nor wear, but are guaranteed against defects in material or workmanship.

Punches

FINISH: NICKEL CHROME PLATED

Chisels



PIN PUNCHES

No.	Length	Diam. Body	Diam. Point	Packing
U-90402	4"	5/16"	2/32"	1 doz.
U-90404	4"	5/16"	3/32"	1 doz.
U-90406	4"	5/16"	4/32"	1 doz.
U-90408	4"	5/16"	5/32"	1 doz.
U-90410	4"	5/16"	6/32"	1 doz.
U-90422	6"	5/16"	7/32"	1/2 doz.
U-90424	6"	5/16"	8/32"	1/2 doz.
U-90426	6"	5/16"	9/32"	1/2 doz.
U-90428	6 1/2"	3/8"	6/32"	1/2 doz.
U-90430	7"	3/8"	7/32"	1/2 doz.
U-90432	7"	3/8"	8/32"	1/2 doz.
U-90434	7 1/2"	1/2"	10/32"	1/2 doz.
U-90581	6"	1/2"	6/32"	1 doz.

* Section Starter Punch - 5/32 Under Size. Black oxide finish.



EXTRA LONG PIN PUNCHES

No.	Length	Diam. Body	Diam. Point	Packing
U-90444	9"	1/2"	6/32"	1/2 doz.
U-90446	9"	1/2"	8/32"	1/2 doz.
U-90448	9"	1/2"	10/32"	1/2 doz.
U-90450	9"	1/2"	12/32"	1/2 doz.



SOLID PUNCHES

No.	Length	Diam. Body	Diam. Point	Packing
U-90462	4 1/2"	5/16"	2/32"	1 doz.
U-90464	5"	3/8"	6/32"	1/2 doz.
U-90466	6"	1/2"	8/32"	1/2 doz.
U-90468	7"	5/8"	10/32"	1/2 doz.
U-90580	6"	1/2"	6/32"	1 doz.

* Ledger Plate Punch - 5/32 Under Size. Black oxide finish.



LONG TAPER DRIFT PUNCHES

No.	Length	Diam. Stock	Point Size	Lgt. of Taper	Packing
U-90482	8"	3/8"	4/32"	3 1/2"	1/2 doz.
U-90484	8 1/2"	1/2"	5/32"	4"	1/2 doz.
U-90486	9"	1/2"	6/32"	6"	1/2 doz.
U-90488	11"	5/8"	8/32"	7"	1/2 doz.



PRICK PUNCHES

No.	Length	Diameter Stock	Packing
U-90570	5"	3/8"	1 doz.



CENTER PUNCHES

No.	Length	Diameter Stock	Packing
U-90574	4"	5/16"	1 doz.
U-90575	4 1/2"	3/8"	1/2 doz.
U-90576	6"	1/2"	1/2 doz.



REGULAR TAPER

No.	Cutting Edge	Diam. Steel	Length	Packing
U-90312	1/4"	1/4"	4 3/4"	1 doz.
U-90314	5/16"	5/16"	5"	1 doz.
U-90316	3/8"	5/16"	5"	1/2 doz.
U-90318	1/2"	3/8"	6"	1/2 doz.
U-90320	5/8"	1/2"	6"	1/2 doz.
U-90322	3/4"	5/8"	7"	1/2 doz.
U-90324	7/8"	3/4"	7 1/2"	1/2 doz.
U-90326	1"	7/8"	8"	1/2 doz.



EXTRA LONG ALLOY CHISELS

No.	Cutting Edge	Diam. Steel	Length	Packing
U-90332	5/8"	1/2"	12"	1/2 doz.
U-90334	3/4"	5/8"	12"	1/2 doz.
U-90336	1"	7/8"	12"	1/2 doz.

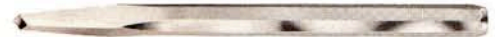

DIAMOND POINT

No.	Cutting Edge	Diam. Steel	Length	Packing
U-90342	5/64"	5/16"	5"	1/2 doz.
U-90344	1/8"	3/8"	6"	1/2 doz.
U-90346	1/4"	3/8"	6"	1/2 doz.
U-90348	3/8"	3/8"	6 1/2"	1/2 doz.



PINCH BARS

No.	Size Stock	Diameter of Point	Length	Width of Flat	Packing
U-90600	5/8"	5/32"	16	7/8"	1/2 doz.



RIVET BUSTERS

Tempered, nickel-chrome finish. Designed especially for cutting off hardened rivet heads. Packed 1/2 dozen to a box.

No.	Cutting Edge	Diam. Steel	Length	Packing
U-90607	3/4"	5/8"	9"	1/2 doz.



RIVET SET No. U-90608

Rivet sets are designed for heading section rivets. Length: 5". Diameter: 5/8". Point: 3/8". Finish: Nickel-Chrome Plated.

1/2 dozen in box - Weight per dozen: 5 lbs.



STAR DRILLS

Cutting edge is slightly oversized and tapered at the point. They can be re-sharpened without losing their original specified cutting size.

Tool No.	Length Cutting Edge	O.A. Length	Dozen Weight
U-90804	1/4"	12"	2 lb.
U-90805	5/16"	12"	2 lb.
U-90806	3/8"	12"	3 lb.
U-90808	1/2"	12"	4 3/4 lb.
U-90810	5/8"	12"	6 1/2 lb.
U-90812	3/4"	12"	8 1/2 lb.
U-90814	7/8"	12"	13 1/4 lb.
U-90816	1"	12"	16 lb.



SPINNER WRENCHES

This series of wrenches has a plastic screwdriver handle and incorporates socket ends ranging from 3/16 inch to 1/2 inch openings. Very convenient for tightening and loosening nuts and bolts with great speed.

Number	Opening	O.A. Length	Weight Lbs.
U-29306	3/16"	6"	.147
U-29308	1/4"	6"	.131
U-29310	5/16"	6"	.156
U-29311	11/32"	6 1/8"	.169
U-29312	3/8"	6 1/8"	.153
U-29314	7/16"	6 1/8"	.216
U-29316	1/2"	6 1/8"	.213

NO. U-88230 SCREW DRIVER DISPLAY

A balanced stock of 50 superior quality screwdrivers on a decorated display designed for wall or counter use 22" x 25 1/2" x 4 1/2". Size and number of each item appears on the display. There is no charge for this silent salesman.

These screwdrivers are made from the finest alloy steel. The blades are hardened full length. The transparent plastic handles are imprinted with stock numbers for ready identification.

*will sell
tools*



Weight - Complete with tools, 24 lbs.

Qty.	No.	Pattern	Size
2	U-90151	Phillips (Stubby)	1 x 2 3/4 in.
2	U-90152	Phillips (Stubby)	2 x 3 1/2 in.
3	U-90033	Standard (Extra Thin Blade)	1/8 x 3 in.
3	U-90123	Clutch Head	5/16 x 4 in.
3	U-90141	Phillips	1 x 3 in.
3	U-90142	Phillips	2 x 4 in.
3	U-90046	Electrician	3/16 x 6 in.
2	U-90050	Electrician	3/16 x 10 in.
2	U-90131	Standard (Hex Bolster)	1/4 x 4 7/8 in.
2	U-90076	Standard (Heavy Duty)	3/8 x 6 in.
2	U-90078	Standard (Heavy Duty)	7/16 x 8 in.
2	U-90010	Standard	7/16 x 10 in.
2	U-90008	Standard	3/8 x 8 in.
2	U-90074	Standard (Heavy Duty)	5/16 x 4 in.
2	U-90006	Standard	5/16 x 6 in.
2	U-90004	Standard	1/4 x 4 in.
3	U-90025	Electrician (Thin Blade)	1/8 x 5 in.
3	U-90023	Electrician (Thin Blade)	1/8 x 3 in.
3	U-90022	Electrician (Thin Blade)	1/8 x 2 in.
2	U-90062	Standard (Stubby)	1/4 x 1 3/4 in.
2	U-90061	Standard (Stubby)	1/4 x 1 in.

Displays will sell tools . . .

UTICA'S varied displays offer the latest in Modern Tool Merchandising. On your counter, wall or in your window, UTICA displays will sell tools. Designed by experts to help you increase your profits on Pliers and Adjustable Wrenches. Your cost is only that of the tools.

Old No. | New No. | Old No. | New No.
NO. R-1 | **U-88211** | **AND R-2** | **U-88241** | **"STOCKING" DISPLAY**

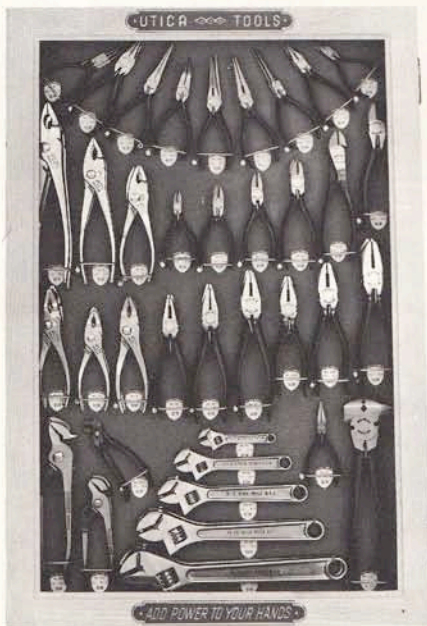

Display made of heavy well-seasoned oak, bleached to a light shade. Backboards are of rich velour-like material on which stocking-type hardware is mounted. Sold with either one or two of each tool.

Old No.	New No.
R1	U-88211 with 1 each tools.
R1	U-88212 with 2 each tools.
R2	U-88241 with 1 each tools.
R2	U-88242 with 2 each tools.

ASSORTMENT NO. R-2
 Display same as R-1 with the 260-7" nipper replacing the 1932-10.

DIMENSIONS
 33" high, 22" wide, 3" deep. Shipping weight:
 One of each number: 39½ lbs. Two of each number: 54½ lbs.

Assortment No. R-1 Display

8-6"	41-5"	517-5"
8-8"	41-6"	622-5"
8-10"	46-4"	650-6"
9-6"	50-6"	654-6"
11-5"	50-7"	777-6"
11-6"	50-8"	888-6"
20-4½"	91-4"	1033-6"
21-4½"	91-6"	1932-10"
22-4½"	91-8"	1950-6"
22-6"	91-10"	1950-7"
39-7"	91-12"	1950-8"
40-7"	507-6½"	
41-4"	507-10"	

NO. H-17 DISPLAY

Stocks twenty-nine UTICA pliers and wrenches. Tools are presented in open bays for easy inspection and handling. Sturdily constructed of fine birch panels with gleaming lucite fronted tool bays. For counter use or hanging on wall or peg-board.

Dimensions: 18" high, 12" wide, 10" deep. Shipping weight 23 lbs.

Old No. | New No.
H-17 | **U-88303** (with 90 Series Wrenches)

(Also available with No. 91 wrenches)

ASSORTMENT

3 — 5-6"	2 — 90-8"
2 — 7-6"	2 — 90-10"
2 — 7-8"	1 — 90-12"
2 — 11-5"	1 — 260-7"
2 — 40-7"	2 — 507-6½"
1 — 41-6"	2 — 507-10"
1 — 50-8"	2 — 654-6"
1 — 90-4"	2 — 1033-6"
2 — 90-6"	

Old No. | New No.
H-17 | **U-88304** (with 91 Series Wrenches)



NOTE: For other information pertaining to dimensions, refer to Mechanical Drawings, Page 17

When ordering, please use new tool number.

Old No. | New No.
NO. H-18 | U-88207 **MERCHANTMAN STOCKING DISPLAY**

(Also available with No. 91 wrenches.) Please indicate whether No. 90 or No. 91 series wrenches are desired, using applicable 5 digit number below.

Contains 18 of the fastest moving tools from UTICA's extensive line of pliers and wrenches. Stocked with two of each number. Display is made of 1/8" peg board with chrome stripping.

ASSORTMENT

2 - 8-6"	2 - 50-7"	2 - 1033-6"
2 - 8-8"	2 - 50-8"	2 - 90-4"
2 - 40-7"	2 - 260-7"	2 - 90-6"
2 - 41-4"	2 - 507-6 1/2"	2 - 90-8"
2 - 41-5"	2 - 507-10"	2 - 90-10"
2 - 41-6"	2 - 654-6"	2 - 90-12"



DIMENSIONS

24" high, 24" wide, 2 1/2" deep. Shipping weight 33 lbs.

New No.
 NO. U-88207 - WITH 90 SERIES WRENCHES
 NO. U-88208 - WITH 91 SERIES WRENCHES

NO. U-88222 SPECIAL ELECTRONIC TOOL DISPLAY

Has a full assortment of the most popular tools for Radio, Television, Electronics and general electrical work. Stocking type with room for 2 or 3 of each tool. Display is made of 1/8" peg board with chrome stripping.

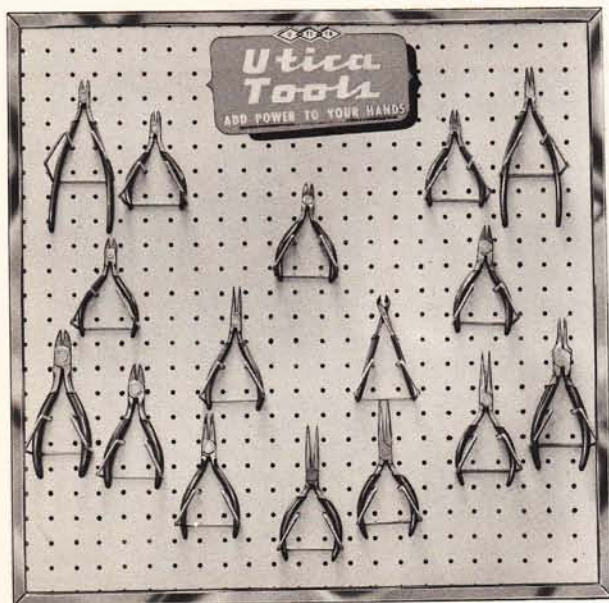

No. **U-88222** - Two Each Tools.
 No. **U-88223** - Three Each Tools.

ASSORTMENT

23-6" GR	49-6" CFS
25-5" GR	64-4" CS
34-6"	146-4"
38-4" CFS	265-5"
42-4" CFS	*654-5 1/2" CFS
44-5" CFS	774-5 1/2" GR
46-4" CFS	896-6" CFS
47-4" CFS	1033-5 1/2" CFGRS

DIMENSIONS

24" wide, 24" high, 2 1/2" deep. Shipping weight:
 Two each number 10 lb. 12 oz. Three each number 13 lbs. 2 oz.

When ordering, please use new tool number.



Old No.	New No.
NO. W-5	U-88305

AND

Old No.	New No.
W-8	U-88308

ADJUSTABLE WRENCH DISPLAYS

In Red and White baked lacquer. Sturdy steel. Has holes for wall mounting and wire easel for window or counter.

ASSORTMENT NO. W-5

2—91-4" 3—91-6" 3—91-8" 2—91-10" 2—91-12"
Service Parts Kit containing a jaw, knurl, pin and spring for each size.

Assortment No. W-8 same as above but with Black finish No. 90 wrenches.

DIMENSIONS

16" high, 12" wide, 2½" deep. Shipping weight 11 lbs.

Old No.	New No.	Old No.
NO. W-9	U-88309	W-10

New No. **U-88310** **WRENCH DISPLAYS**

UTICA'S SELECT-O-LOCK® wrenches are attractively displayed in a modern Self-Service Merchandiser. The display is brilliant four-color baked lacquer on sturdy steel, with holes for wall mounting.

ASSORTMENT NO. W-9

3—93-6" 4—93-8" 3—93-10" 2—93-12"
Service Parts Kit which includes jaw, knurl, pin and spring for each size.

Assortment No. W-10 same as above but with Black finish No. 94 wrenches.

DIMENSIONS

16" high, 12" wide, 3" deep. Shipping weight 11½ lbs.



When ordering, please use new tool number.



Old No. | New No.
NO. J-2 | U-88302

MIDGET TOOL DISPLAY CARD

A five unit assortment consisting of one each Midget pliers . . . 65-4½" CF, 20-4½"CF, 21-4½"CF, 22-4½"CF and 46-4"CF. All tools in this unit have plastisol dipped handles for added comfort and wearability. Compact, colorful display packed securely in corrugated carton. Shipping weight 1 lb.



Special Displays

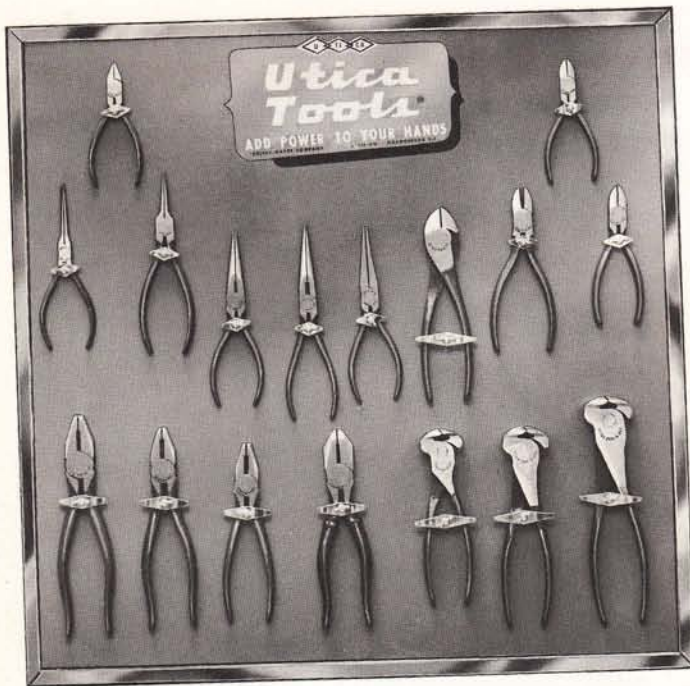

Two typical Special Displays are illustrated on this page. They have been made with special tool assortments and dimensions to meet customers specifications.

In addition to the cases shown in this catalog, special panel or wall displays will be designed to customer specifications... these are also supplied for the cost of the tools only.

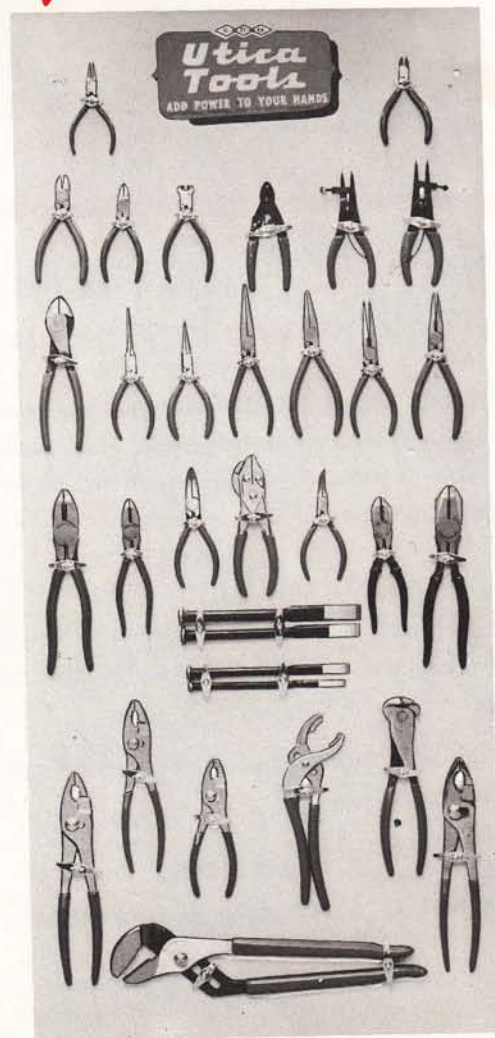

When ordering, please use new tool number.

WHAT SHOULD A PREMIUM OR BUSINESS GIFT DO?



Old No. | New No.

GP-3 (U-84802). Genuine Pigskin Wallet that fits easily into pocket, Contains one each: No. 50-4" Side Cutting Pliers . . . No. 517-5" Slip Joint Pliers . . . No. 22-4" Short Chain Nose Pliers . . . No. U-90022 Screwdriver. All except screwdriver, have full polished heads and red "Cushion-Grip" handles. Packed in gold colored gift box and corrugated mailer.

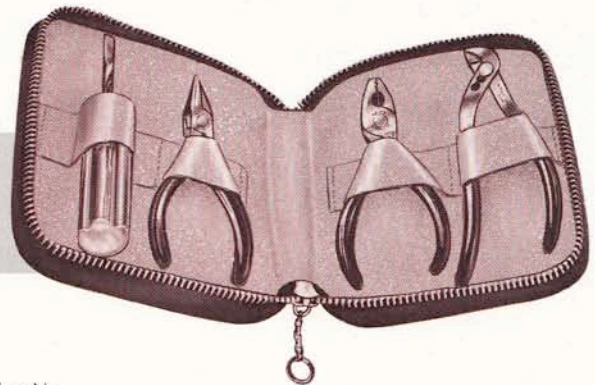

Old No. | New No.

Kit GP-6 U-84804. Genuine red leather wallet. Fits easily into pocket. Contains one each: No. 50-4" Side Cutting Pliers . . . No. 517-5" Slip Joint Pliers . . . No. 22-4" Short Chain Nose Pliers . . . No. U-90022 Screwdriver. All tools except screwdriver, have red "Cushion-Grip" handles. Available in gold colored gift box and corrugated mailer.

It should be a lasting frequent and useful reminder of the giver!

In every home-workshop . . . in every household Kitchen . . . in every office . . . in every store . . . THERE IS A NEED FOR UTICA TOOLS!

From this attractive, colorful selection of tool kits you can choose a gift or a premium of unquestioned distinction. The name of Utica has been a guarantee of top professional quality for over half a century. The wide variety will accommodate almost every budget.

IMPRINTING: All kits can be imprinted with your name or message in gold or white letters.

Please address all correspondence and orders to:



UTICA TOOL CO., INC.

Subsidiary of The Triangle Corporation
Orangeburg, South Carolina 29115

When ordering, please use new tool number.

UTICA

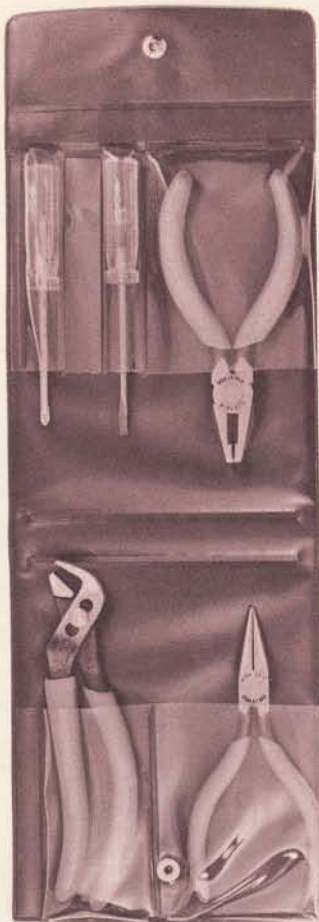

Old No.	New No.
---------	---------

Kit K-10 U-84816 . Reinforced vinyl, with clear plastic pockets and snap fastener. Contains one each: No. 50-4" Side Cutting Pliers . . . No. 517-5" Slip Joint Pliers . . . No. 22-4" Short Chain Nose Pliers . . . all with red "Cushion-Grip" handles . . . No. U-90020 Screwdriver . . . No. U-90140 Midget Phillips Head Screwdriver. Packed in corrugated mailer.



Old No.	New No.
---------	---------

Kit PR-15 U-84824 . Reinforced vinyl, clear plastic pockets. Contains one each: No. 93-6" Adjustable Locking Wrench . . . No. 11-6" Combination Slip Joint Pliers . . . No. U-90023 Screwdriver . . . No. U-90141 Phillips Head Screwdriver. Packed in corrugated mailer.

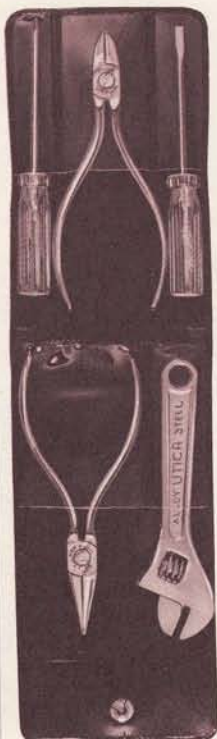

Old No.	New No.
---------	---------

Kit K-12 U-84818 . Vinyl, with clear plastic pockets and snap fasteners. Contains one each: No. 22-4" Short Chain Nose Pliers . . . No. 46-4" Diagonal Cutting Pliers, both full polished . . . No. 91-4" Adjustable Wrench with polished head . . . No. U-90020 Screwdriver . . . No. U-90140 Midget Phillips Head Screwdriver.



Old No.	New No.
---------	---------

Kit K-4 U-84813 . Vinyl, clear plastic pockets, snap fasteners. Contains one each: No. 8-6" Combination Slip Joint Pliers . . . No. 93-6" Adjustable Locking Wrench . . . No. U-90004 Screwdriver . . . No. U-90141 Phillips Head Screwdriver. Packed in corrugated mailer.

If Special Kits are desired, write:
Utica Tools
Orangeburg, South Carolina



QUALITY TOOLS

DECIMAL EQUIVALENT CHART

	$\frac{1}{64}$.015625		$\frac{33}{64}$.515625
$\frac{1}{32}$	$\frac{3}{64}$.03125		$\frac{35}{64}$.53125
	$\frac{5}{64}$.046875	$\frac{9}{16}$	$\frac{37}{64}$.546875
$\frac{1}{16}$	$\frac{7}{64}$.0625		$\frac{39}{64}$.5625
	$\frac{9}{64}$.078125	$\frac{19}{32}$	$\frac{41}{64}$.578125
$\frac{3}{32}$	$\frac{11}{64}$.09375		$\frac{43}{64}$.59375
	$\frac{13}{64}$.109375	$\frac{5}{8}$	$\frac{45}{64}$.609375
$\frac{1}{8}$	$\frac{15}{64}$.125		$\frac{47}{64}$.625
	$\frac{17}{64}$.140625	$\frac{21}{32}$	$\frac{49}{64}$.640625
$\frac{5}{32}$	$\frac{19}{64}$.15625		$\frac{51}{64}$.65625
	$\frac{21}{64}$.171875	$\frac{11}{16}$	$\frac{53}{64}$.671875
$\frac{3}{16}$	$\frac{23}{64}$.1875		$\frac{55}{64}$.6875
	$\frac{25}{64}$.203125	$\frac{23}{32}$	$\frac{57}{64}$.703125
$\frac{7}{32}$	$\frac{27}{64}$.21875		$\frac{59}{64}$.71875
	$\frac{29}{64}$.234375	$\frac{47}{64}$	$\frac{61}{64}$.734375
$\frac{15}{64}$	$\frac{31}{64}$.250		$\frac{63}{64}$.750
$\frac{1}{4}$.265625	$\frac{3}{4}$.765625
		.28125			.78125
$\frac{9}{32}$.296875	$\frac{25}{32}$.796875
		.3125	$\frac{13}{16}$.8125
$\frac{5}{16}$.328125			.828125
		.34375	$\frac{27}{32}$.84375
$\frac{11}{32}$.359375			.859375
		.375	$\frac{55}{64}$.875
$\frac{3}{8}$.390625			.890625
		.40625	$\frac{7}{8}$.90625
$\frac{13}{32}$.421875			.921875
		.4375	$\frac{29}{32}$.9375
$\frac{7}{16}$.453125			.953125
		.46875	$\frac{15}{16}$.96875
$\frac{15}{32}$.484375			.984375
		.500	$\frac{31}{32}$.99375
$\frac{1}{2}$					1.000

UTICA TOOL CO., INC.

Subsidiary of The Triangle Corporation
Orangeburg, South Carolina 29115



HAND TOOLS FOR INDUSTRY SINCE 1895



**THE
UTICA
TOOL CO.,
INC.**



From a modest beginning with a handful of employees, the Utica Tool Company has grown into a well-known and respected multi-line organization that manufactures a wide variety of hand tools for a broad range of industries.

The Utica Tool Company, Inc. originated with the founding of the Utica Drop Forge and Tool Company by W. Pierrepont White and Hugh White in 1895 to manufacture nippers. The original building burned to the ground in 1907, but with the completion of a new, larger plant in 1908 a complete line of pliers was added to the product line. About 1923, the late W. E. Lewis bought control of the company, and, in 1936, the product line was again expanded to include adjustable wrenches. From 1940 to 1945, when the Company produced a variety of special tools for the Defense Department, employment grew from 130 to 535.

In 1956, Utica Drop Forge and Tool was purchased by the Kelsey-Hayes Company of Detroit, Michigan. In 1961, the Herbrand Automotive Tool line was purchased from Bingham-Herbrand of Fremont, Ohio. Then, in 1962, Kelsey-Hayes moved the combined Utica and Herbrand operations from Utica, New York, to a modern plant in Orangeburg, South Carolina. Bonney Tools were added to the automotive line in April, 1964. In September of 1967, the Utica Tool Company was purchased from the Kelsey-Hayes Company by The Triangle Corp. and now operates as a wholly owned subsidiary.

The magnificent Orangeburg plant pictured at the top of this page is the largest hand tool manufacturing plant in America under one roof. It occupies over 400,000 square feet of space, fully air-conditioned, and now produces pliers in some 250 standard models, over 1000 special model pliers made to customer specifications, and an automotive tool line that includes some 3600 different catalog items to meet the hand tool needs of industries and individuals in markets of the world.



IT'S



EVERYWHERE

UTICA IS DEDICATED TO THE TOOL BUSINESS

Utica Tool Company, Inc. and its parent company, The Triangle Corporation are dedicated *only* to the manufacture and marketing of highest quality, professional hand tools.

A tremendous, standing inventory for most popular tools means immediate shipment.

A new customer satisfaction policy indicates the great lengths to which this great tool company will go to establish a preference by seller and user alike for Utica tools.

New, computerized systems assure fast handling of orders, up to the minute records of inventory by lines and individual tools, minimum back-orders, accurate order filling and shipping.

This is a *customer* oriented company. Think first of Utica. You will find that we constantly strive to be first with the new tools and first to get them to you.

UTICA SALES OFFICES

Atlanta, Ga.	Minneapolis, Minn.
Boston, Mass.	Montreal, Quebec
Charlotte, N.C.	New York City, N.Y.
Chicago, Illinois	Orangeburg, S.C.
Cincinnati, Ohio	Orlando, Florida
Dallas, Texas	Philadelphia, Penn.
Denver, Colo.	St. Louis, Mo.
Detroit, Mich.	San Francisco, Calif.
Honolulu	Seattle, Wash.
Indianapolis, Ind.	Toronto, Ont.
Kansas City, Kan.	Utica, N.Y.
Los Angeles, Calif.	

UTICA TOOL WAREHOUSES

UTICA TOOL CO., INC.

Subsidiary of The Triangle Corporation

Cameron Road
Orangeburg, South Carolina
Phone 803-534-7010

Northeast Service Company

Post Office Box 130
Sprucedale Road
Woodstock, Connecticut
Phone 203-928-6581

Dillon Stevens Company

1610 South Bonnie Brae Street
Los Angeles, California
Phone 213-747-9221

